

Wheelchair User Manual



Uni Series



**IMPORTANT: -
DO NOT USE YOUR WHEELCHAIR UNTIL THIS MANUAL HAS BEEN READ
AND UNDERSTOOD.**

A C T I V E D A I L Y L I V I N G

Contents

AMENDMENT RECORD	2
1.0 Important information	3
2.0 Intended User and Intended Use.....	6
3.0 Wheelchair features.....	8
4.0 Wheelchair set-up for use	11
5.0 Wheelchair operation	16
6.0 Transporting your wheelchair.	22
7.0 Wheelchair cleaning and maintenance.....	25
8.0 Optional features and accessories.....	27
9.0 Disposal / recycling of materials.....	41
10.0 Warranty	41
11.0 Wheelchair dimensions	42
12.0 Wheelchair specification	42
12.2 Identification of UNI wheelchairs.....	43

AMENDMENT RECORD

ISSUE	PAGE	AMENDMENT	DATE
5	p32	ELR/ALR warning amended	June 2007
5a	Front & back cover	Sunrise Logo added	Feb 08
5b	Updated front & rear cover, p5 p41	Updated references to 2007/47/EEC. Life expectancy added	Mar 2010

1.0 Important information

1.1 Important symbols in this manual

1.2 Wheelchair Identification

1.3 Labels Fitted to the wheelchair

1.4 Rules and regulations

1.5 Modifications and alterations

Please read this information carefully or have the complete contents of this user manual explained to you in detail. If there are any points you are not absolutely clear about ask your healthcare specialist * to clarify them, during any official handover, before attempting to use this equipment for the first time.



This manual contains important hints and information on: -

- **Safety**
- **Operation**
- **Care and maintenance**

The contents of this manual are intended to cover all the general points relating to your new wheelchair. As part of our ongoing product improvement and development programme, changes may take place at short notice. This wheelchair may have been prescribed specifically for you and may have features not detailed in this literature.

In order to ensure you gain maximum benefit and full enjoyment from your wheelchair, arrangements may have been made to carry out an official handover shortly after delivery. Your healthcare specialist* will notify you of this in advance. If not please contact your Wheelchair Service.





Prior to delivery, your wheelchair will have undergone a thorough pre-delivery inspection by our factory-trained staff. Before using your wheelchair, you should have received appropriate instruction from your healthcare advisor, therapist or rehabilitation engineer.

The visiting healthcare specialist * will carry out a series of final safety checks. Account will be taken of your clinical requirements as well as your social and environmental needs, including all necessary adjustments to ensure optimum comfort.

Neither Sunrise Medical (the equipment manufacturers) nor the distributor or prescribing Authority (NHS) will accept responsibility for damage or injury caused by misuse or non-compliance with instructions or advice set out in this manual.

* Your Healthcare Specialist may be a Rehabilitation Engineer or Occupational Therapist or Wheelchair Service Personnel.

1.1 Important symbols in this manual

	<p>THIS SYMBOL WARNS YOU OF A RISK! This symbol is used to give a warning or caution that is related to the safe use of the wheelchair, follow the instructions to avoid personal injury or damage to the product.</p>
	<p>This symbol indicates hints and suggestions, which should help make operating the wheelchair easier and point out any special functions.</p>
	<p>This symbol indicates hints and suggestions that should not be carried out while operating the wheelchair.</p>
	<p>This symbol indicates the use of different tools and other adjustments or service/maintenance may be required. It should only be carried out by suitably trained or competent persons.</p>

1.2 Wheelchair Identification

Each wheelchair carries a unique identification/serial number that is printed on the serial number label. This label is fitted on the left hand side of the wheelchair on the rear vertical or horizontal frame tube. Figures 1, 2 and 3 show the positioning of the serial number label on the rear of the wheelchair.

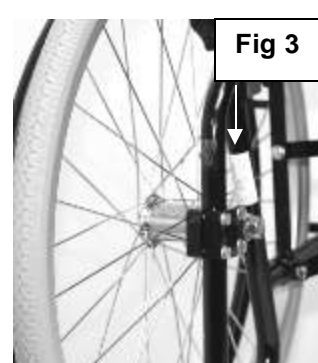
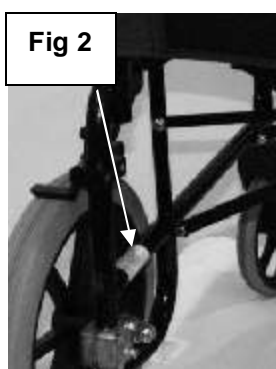
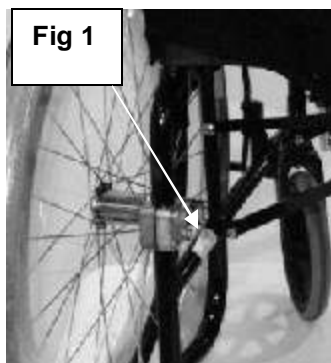





This label also carries the model code designation, which includes the wheelchair size and colour. In the event of any queries please have this information to hand if contacting Sunrise Medical.

Sunrise Medical Ltd
High Street
Wollaston
West Midlands
DY8 4PS

Telephone :- 01384 446622
 Telfax:- 01384 446644

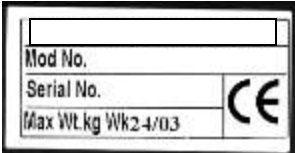
1.3 Labels Fitted to the wheelchair

Label	Label meaning
	<p>This label shows the position of tie down location points for wheelchair transport. (See chapter 6.3 on transportation)</p>
	<p>This label shows an example of the maximum user's weight for the wheelchair. It is fitted on the right hand seat rail</p>
	<p>This label shows the model number, serial number, max weight and manufacturer details. See below for location.</p>
	<p>This label shows the canvas Flame retardency details, the label is fitted to the rear of the backrest canvas.</p>

1.4 Rules and regulations

The wheelchair is manufactured to meet the requirements of *Medical Devices Directive 93/42/EEC*, BS EN 12183 and ISO 7176-19 – *Wheeled mobility devices for use in motor vehicles*.

- The wheelchair and occupant is capable of being transported in a vehicle using an approved Wheelchair Tie Down Restraint System (WTORS)
- The Upholstery meets the requirements of ISO 7176-16 and the fire and furnishing regulations SI1324. Other materials wherever possible are ignition retardant.
- Sunrise Medical declares under its sole responsibility that this product is in conformity with the requirements of directive 93/42/EEC amended by 2007/47/EEC.

1.5 Modifications and alterations

Making any unauthorised modifications or using non-approved parts, may change the wheelchair structure and create an unsafe condition.

 **Neither Sunrise Medical nor your wheelchair provider will accept responsibility for damage caused by misuse or non-compliance with instructions or advice set out in this manual.**

 **Users attempting to use the wheelchair beyond the manufacturer's recommendations may put themselves at risk of serious injury or even death.**

 **Should the physical capabilities required to push the wheelchair be beyond the user, carer or attendant consult with your wheelchair provider. It is possible a powered wheelchair may be more appropriate for your needs.**

 **Should there be any changes in your condition or ability (including factors such as body weight) then seek advice from your wheelchair provider or healthcare professional for further advice and information.**

2.2 Intended use

Your wheelchair is intended for use in the home, the office, public places and buildings and similar locations on pavements, pedestrian paths and firm surfaces. It is intended to assist with the mobility of the user on the seat and should not be used as a ladder or as a means of pulling or transporting items, or similar.

 **Do not use the wheelchair on soft surfaces such as sand, deep snow, slush or mud as this may affect the stability.**

 **Care should be exercised when using the wheelchair on wet or slippery surfaces such as wet cobbles or icy pavements, as these may cause the wheels to slip or may cause carers/attendants controlling the wheelchair to slip.**

Using your wheelchair during darkness or poorly lit areas

When using your wheelchair during darkness or in poorly lit areas then consideration should be given to the use of high visibility markers or reflectors that can be fitted to the wheelchair or the use of high visibility/reflective clothing such as fluorescent waistcoats, belts or armbands, particularly in poorly lit areas or when crossing the road.

Maximum safe slope

The maximum safe slope for this wheelchair is 9 degrees. (This represents a slope of approx 1 in 6)

See further notes and guidance in section 5.5 on **wheelchair stability**

 **Users, carers and attendants attempting to use the wheelchair beyond the manufacturer's recommendations may put themselves at risk of serious injury or even death.**

3.0 Wheelchair features

3.1 Description of the wheelchair

The **Uni 8 Series** self-propelling folding wheelchairs can be fitted with either 61cm (24") or 56cm (22") diameter wheels or the **Uni 9 Series** are fitted with 31cm (12.5") diameter wheels. The standard configuration is shown in the figures below, which identifies key components.

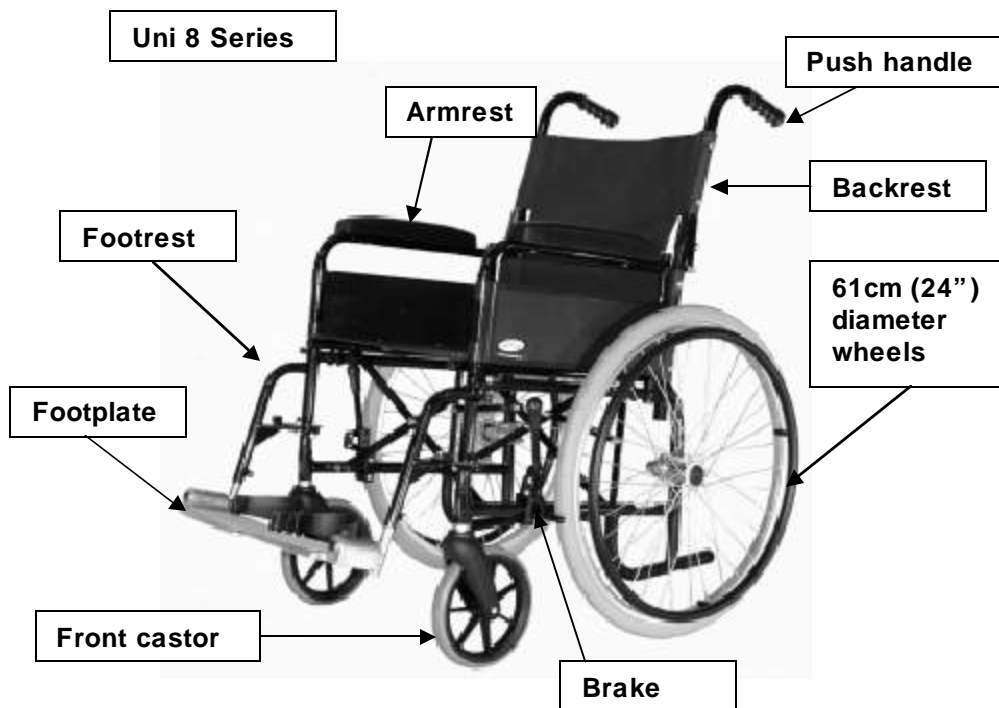

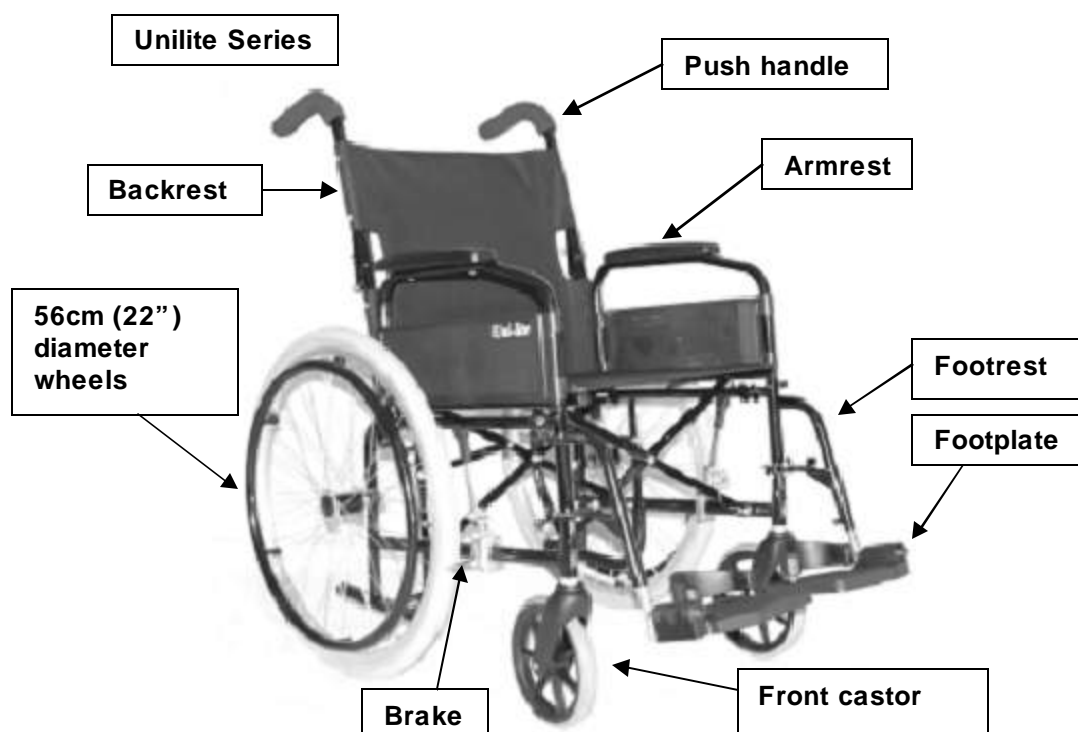

The wheelchair can be used for transporting the occupant as a seat in a motor vehicle. It must be used with the appropriate wheelchair tie down restraints and occupant restraints. See **chapter 6.0** on Transportation for further details. Instruction is also given for transporting the wheelchair when not occupied.

For details on the specification see section 12.

Instructions on how to fold and un-fold the wheelchair are given in the section 4.3.

3.2 Wheelchair weights

Typical overall weights of the wheelchair, including armrests and footrests, in standard configuration, are as follows: -

Self-Propelling Uni 8 Series: - 19 Kg

Attendant Push Uni 9 Series: - 16 Kg

Self Propelling Unilite series: - 17Kg

Attendant Push Unilite series: - 14Kg

(The larger the wheelchair the more mass it will have, the exact weight will depend upon the configuration.)

The following parts of the wheelchair are removable: -

Armrests

Footrests

Some types of backrest extensions

Domed headrests

Quick release wheels if fitted

The weights of these parts are as follows: -

Armrest 0.9Kg each

Footrest & footplate 1 Kg each

Domed Headrest Extension (if fitted) 0.7Kg

Backrest Extension (if fitted) 0.5Kg

Quick Release wheels (if fitted) 2Kg each

Other additional accessories will add further to the weight of the wheelchair.

 **The removal of detachable parts that are supplied either as standard or optional requirements as proscribed or recommended by the user' s prescriber, healthcare professional or wheelchair dealer, other than for the purpose of storing or transporting the wheelchair is not recommended and may compromise the correct use of the wheelchair by the user and the provision of any beneficial effects from the complete equipment.**

 **Take precautions when using your wheelchair to avoid fire risks, such as avoiding smoking or parking against open fires or heat source.**

Remember also that direct heat such as sunlight will increase the temperature of parts on the wheelchair such as the frame and they may be hot to touch.

Low temperatures such as frost will have the opposite effect and may make parts of the frame very cold to touch.

Your wheelchair may be supplied with pneumatic tyres on the rear wheels. If these are punctured you should inform your wheelchair dealer or repair contractor or wheelchair service in order that they can be repaired correctly and that the wheel function can be checked after repair. Solid tyres are available as options.

Additional equipment options are available for more details on these options see section 8.0 on optional features.

4.0 Wheelchair set-up for use

4.1 Footplate Angle and Height adjustment

4.2 Heel Loops

4.3 Folding and unfolding the wheelchair for use

4.4 Cushion

4.5 Armrests

4.6 Brakes

Your wheelchair should be delivered already assembled. You should remove any packaging before use. If you have not used a wheelchair or are uncertain about any of the features of your wheelchair then please contact your healthcare professional or wheelchair dealer or your wheelchair service and ask for assistance. If you have been informed that you must receive specific instructions about your wheelchair before using it then it is important that you await this instruction for your own safety.

This advice also applies to carers or attendants who are not familiar with the use of the wheelchair in order to ensure the safety of the occupant.

Before using the wheelchair ensure that the following adjustments/set up have been carried out. It is recommended that any adjustments to your wheelchair, be carried out by suitably trained, or qualified personnel. The information on adjustments below is intended for Healthcare Specialists.

4.1 Footplate adjustment

Both the height and the angle of the footplate are adjustable. It is recommended that the footplates should not be set lower than 63mm or 2 inches.

Height adjustment

 With the user sitting in the wheelchair, lower the footplate and ensure that it is in a comfortable position for their feet. The safest position is usually with thighs horizontal, and hips and knees at right angles. If the position is not comfortable the footplate can be adjusted as follows:

Loosen the Bolt A with a spanner; slide the footplate stem up or down to the desired position to position the footplate at the correct height, and then re-tighten Bolt A securely after adjustment.

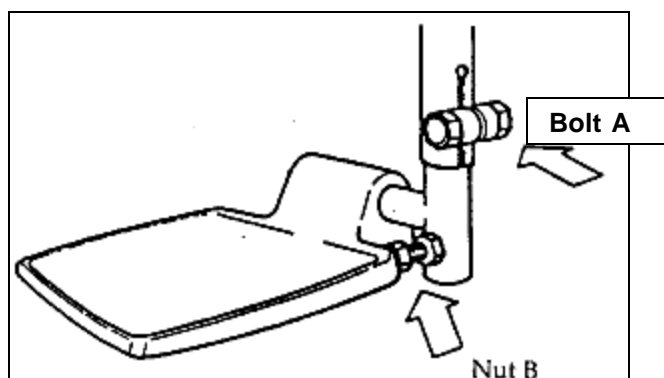

Angle adjustment

 The angle of the footplate can be adjusted by loosening nut B, adjusting the screw to move the footplate up or down and re-tighten nut B after adjustment.

It is easier and safer to get into your wheelchair if you turn the footplates up and out of the way or take them off the wheelchair.

To detach the footrest assembly: -

Pull the latch **C** towards the back of the wheelchair and the footrest will then swing outwards and lift off the pivot pins.

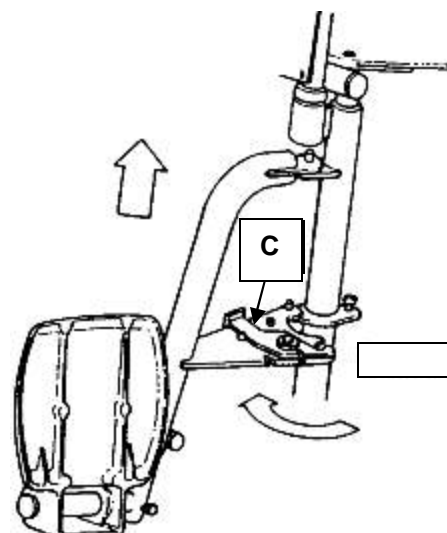

To attach the footrest assembly: -

Locate the holes on the footrest assembly onto the pivot pins on the wheelchair. Swing the footrest inwards until the locking latch **C** engages

A small spring “R” clip may be fitted to prevent the footrest from detaching when the wheelchair is lifted into a car boot.

4.2 Heel loops

Heel loops may be fitted to the footplates. These should be turned to rear of the wheelchair when the footplates are in the down position

4.3 folding and unfolding the wheelchair for use

Unfolding the backrest

To put the backrest in the upright position, push the handles upwards and forwards and then slide the levers (A) downwards fully.

Folding the backrest

The backrest can be folded to make storage of the wheelchair easier.

To fold the backrest, stand behind the wheelchair, grip the two small levers (A) positioned on each side of the backrest (just above the armrests) and slide them upwards. Fold the backrest down.

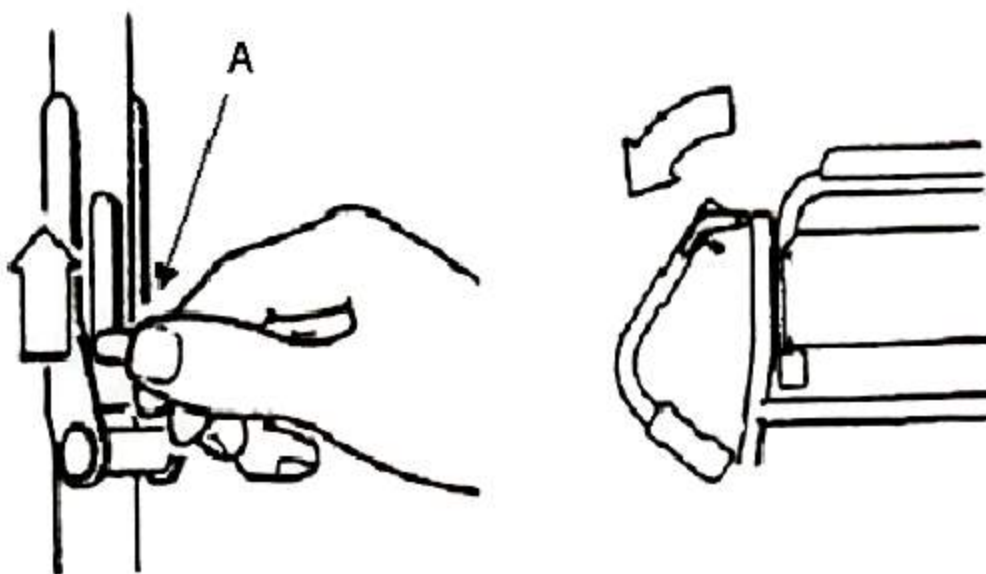

Unfolding the complete wheelchair

1. Take hold of one or both of the push handles and pull the backrest into the upright position. Make sure that it is locked in this position by sliding the levers down fully. Ensure both push handles are locked in position.
2. Turn the fingers towards the MIDDLE of the seat and push down on the side of the seat with the flat of the hand until the chair is completely open.

⚠ Never put your fingers round the sides of the seat because they can get trapped between the seat and the frame.

The wheelchair is fully open when the seat is taut and flat.

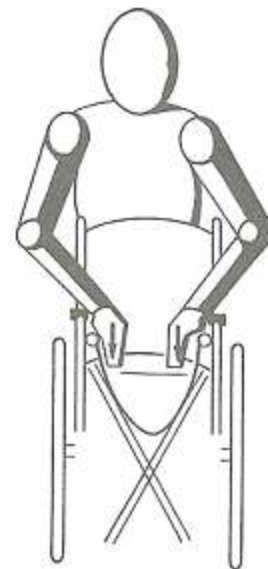

Folding the wheelchair for storage

1. Turn the heel loops, if fitted, to the front of the footplate and then flip up the footplates.
2. Grasp the middle of the seat fabric at both front and rear and give a sharp pull upwards. This will partially close the chair.
3. Push both sides together to fold the chair completely. Ensure that the seat is not trapped in the frame when fully folded.
4. If required, fold the backrest down by pulling up the levers and lowering the push handles as shown on the previous page.



4.4 Cushion

If your wheelchair is supplied with a cushion this may be held in position by Velcro strips underneath the cushion, which attaches to corresponding Velcro strips on the topside of the seat. The cushion should be replaced after unfolding the wheelchair and removed before folding the wheelchair.

- Ensure the cushion is located in the centre of the seat.

⚠ Using a cushion raises the seated position and may reduce the stability of your wheelchair.

Some wheelchairs may be fitted with options or accessories. These are described in the Section headed Options & Accessories.

⚠ Some options and accessories may also affect stability. Your healthcare professional can provide guidance on the stability of your wheelchairs and should be consulted when cushions and accessories are being used.

4.5 Armrests

The armrests are detachable to enable sideways transfer or storage to reduce the weight of the wheelchair. If the armrests have been removed for storage or lifting the wheelchair, they should be replaced as follows: -

Replacing the armrest

Put the armrest tubes into the armrest sockets. Press down on the armrest until it clicks into position.

Removing the armrests

Turn the armrest lock lever A upwards and at the same time hold the armrest at the centre and lift it out of the sockets at the front and the rear.

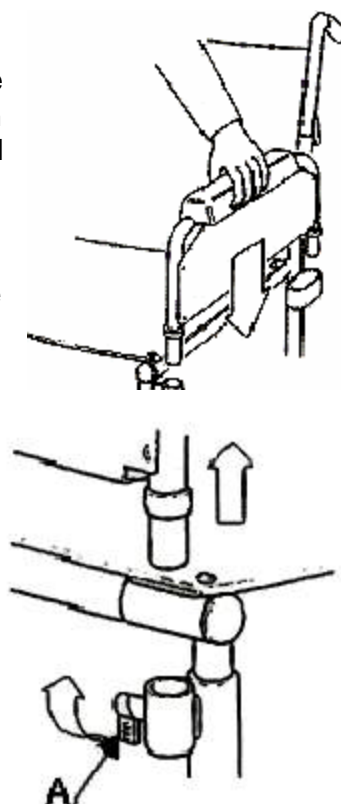

4.6 Brakes

The wheelchair brakes can be applied as follows: -

- Push the brake handle forward firmly.
- Ensure both the brakes on both sides are applied.

The wheelchair brakes can be released as follows: -

- Pull the brake lever fully backwards to ensure that the brake bar is clear of the wheel. Ensure the brakes on both sides are released.
- When releasing the brakes ensure the chair is stationary on a flat/level surface.
- Always apply the brakes when getting into and out of the wheelchair.
- Wheel brakes are not designed to slow the wheelchair down when it is moving. Wheel brakes hold the chair in place when it is at a complete stop.



It is recommended that any adjustments to your wheelchair brakes be made by suitably trained or qualified personnel.

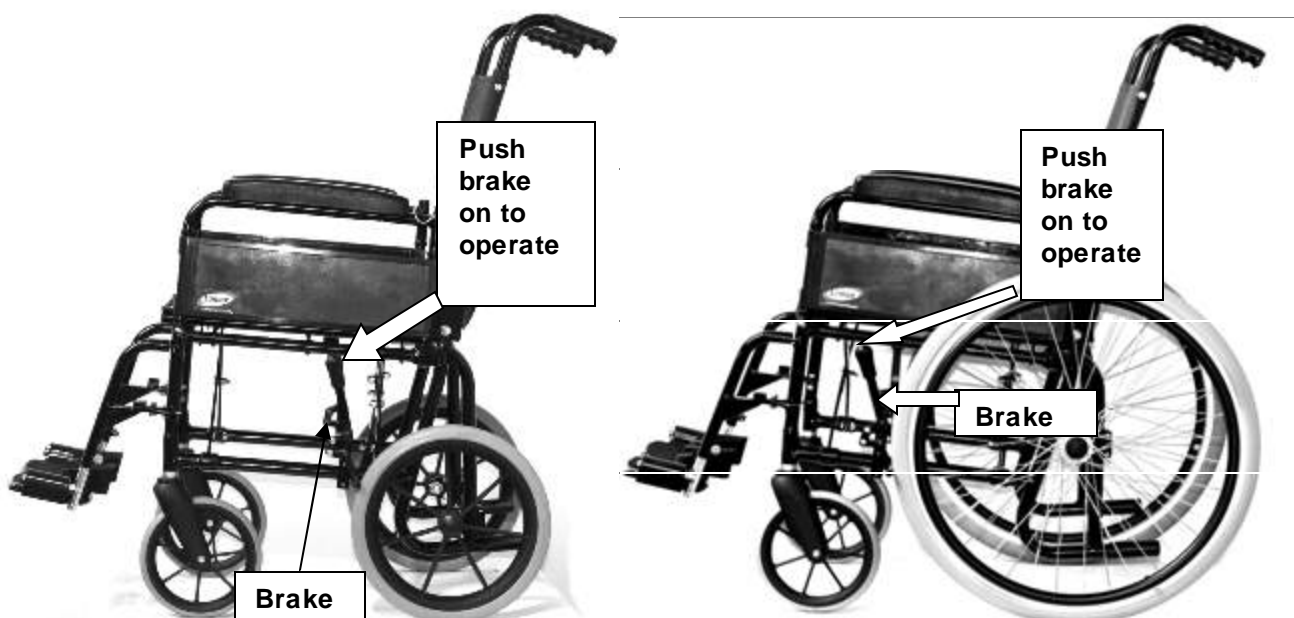

Earlier attendant push wheelchairs may be fitted with the brake as shown below



Attendant operated hub brakes

If fitted hub or drum brakes operate on certain type of self-propelling and transit type wheels. These allow the attendant to operate the brakes and control the brakes whilst moving e.g. uphill or downhill as well as being used as a parking brake when the wheelchair is stationary.

To operate these brakes: -

Grip the lever handles at the rear of the backrest on the push handle and squeeze gently to operate the brakes. The handles have a locking mechanism which operates to lock the brake when it is squeezed to keep the brakes applied or have a thumb pin which when pushed inwards lock the brakes on.

To release the brakes: -

Gently squeeze the handles and then flip the lock trigger off. Take care when releasing the brakes to ensure that the wheelchair is not going to go out of control by holding the push handles securely e.g. when on a slope.



5.0 Wheelchair operation

5.1 Getting into and out of a wheelchair independently

5.2 Sideways transfer

5.3 Seat belt

5.4 How to use your wheelchair

5.5 Wheelchair stability

5.1 Getting into a wheelchair independently

- The wheelchair should be pushed up against a wall or solid piece of furniture;
- The brakes should be on;
- The footplates should be hinged up;
- The user can then lower himself into the chair;
- The footplates should then be pushed down and the feet rested on them in front of the heel loops.



Getting out of a wheelchair independently

- The brakes should be on;
- The hinged footplates should be hinged up;
- With one hand on each armrest, the person should bend slightly forward to bring the body weight to the front of the seat, and with both feet firmly on the ground, one foot well back, push up into the upright position.



 **When standing, do not stand on the footplates or the wheelchair will tip up.**

5.2 Sideways transfer

- The user should check that the brakes are on;
- The footplates should be hinged up or swung away and the feet placed firmly on the ground;
- The armrest on the transfer side must be removed, swung away or swung back;
- The user should bend slightly forward and, with one hand placed on the bed/chair/WC and the other hand on the opposite armrest, transfer across;
- A smooth, sliding board between wheelchair and bed allows the user to slide across.



 **TRANSFERRING CAUTION: Always engage the wheel brakes before transferring in or out of your wheelchair.**

5.3 Seat belt

⚠ Before using your wheelchair ensure the seat belt is worn and correctly adjusted before use.

The seat belt is fitted to the wheelchair as shown in the illustrations. The seat belt support loops are fitted to the backrest frame using the existing lower backrest screw fitted through the eyelet of the belt loop.

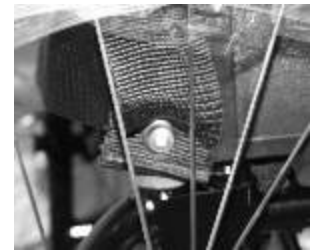

⚠ It is important that the belt is routed around the back of the wheelchair. The buckle end can be fed between the armrest and backrest.



Adjust the belt position so buckles are in the centre of the seat.

Adjust seat belt to suit the user's needs as follows:-

To increase the belt length: - To reduce the belt length: -



Feed free belt through slide adjusters and male buckle to provide more belt length.

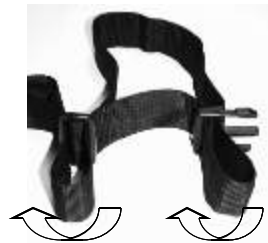

Feed free belt back through male buckle and slide adjusters.



Ensure belt is not looped at male buckle

When fastened check space between belt and user, when correctly adjusted it should be possible to insert the flat of the hand between the belt and user.



Generally the Lap Belt should be fixed so that the straps sit at an angle of approximately 45°, and when correctly adjusted should not allow user to slip down in the seat.

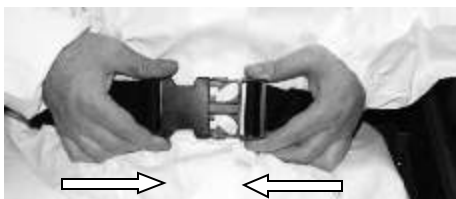

To fasten buckle: -
Firmly push male buckle into female buckle.



To release belt: -
Press exposed sides of male buckle and push towards centre whilst gently pulling apart.

⚠ If in doubt about the use and operation of the seat belt then ask your healthcare professional, wheelchair dealer, carer or attendant for assistance.

⚠ Do not rely on the seat belt only when the wheelchair and occupant are transported in a vehicle, use the separate occupant lap and diagonal restraints provided in the vehicle.

5.4 How to use your wheelchair

Whenever using your wheelchair you should carry out the following checks before setting out:

- Ensure that the rear tyres are inflated correctly if pneumatic tyres are fitted. The tyre pressure is 370Kpa (60psi/4.0Bar). If the tyres are not inflated correctly this may affect the brake function.
- Ensure that the brakes are secure and are functioning correctly by applying the brake and ensuring that the brake bar makes contact with the tyre.
- Check that the front castors swivel freely and the wheels rotate freely and the tyres are free from damage.
- Check that the rear wheels are free from damage including any damaged, loose or bent spokes on self-propelling wheels.
- Check that the seat and backrest are not damaged by cuts or tears or that there is no sign of excessive sagging.
- Ensure that any removable parts have been refitted to the wheelchair
- Check that any detachable parts such as armrest and footrests which when refitted are secured and will not detach when using the wheelchair.

Occupant control

Occupant control (self-propelled) chairs only have hand rims fitted on the outside of the rear wheels.

1. By gripping the hand rims and pushing or pulling round the hand rim, the wheelchair can be propelled either forward or backwards.
 2. By pulling one wheel backwards and one wheel forwards, using the hand rims the wheelchair can be turned around in a tight space.
- Check that there are no obstacles or people on the turning space before starting this procedure.

Many pavements and roads slope towards the kerb and this may cause the wheelchair to veer to one side. To counteract this it may be necessary to steer the wheelchair in the opposite direction. Avoiding uneven or soft ground and utilising drop kerbs whenever possible may make the journey more comfortable. The tyre grip of the wheelchair is affected by the surface over which the wheelchair is pushed. Therefore, extra care should be taken when weather conditions cause wet or icy surfaces.

- Make sure that the brakes are always on when the chair is not being pushed.
- Make sure that both feet are safely on the footplates and that clothing is safely tucked in and cannot catch in the wheels.
- Use both hands on the push handles to control the chair.
- Look well ahead to avoid hazards (e.g. furniture, doors, etc.)
- Avoid steep and uneven surfaces because the chair may tip over.
- Avoid soft surfaces because the castors may get stuck.
- Try to achieve a smooth steady ride.



DO NOT turn too quickly.



DO NOT propel the wheelchair at speed in excess of normal walking pace.



DO NOT hang items such as bags or rucksacks on the back of the push handles, as this can overload the chair and affect the stability of the wheelchair - causing it to tip over.



Doing a “wheelie” i.e. tilting the wheelchair backward to its balance point can be dangerous. Do not attempt this manoeuvre!!

Attendant pushing

Keep in contact with the person in the chair. If you stop to look in shop windows or talk to people; remember to turn the chair so that the person in the chair does not have to turn or lean.

 **DO NOT** exceed the occupant weight limit for your chair and do not carry more than one person. If you feel that your body weight may have changed then contact your healthcare specialist.

- Ensure that all parts of the user' s body and clothing, including any rugs or blankets, are clear of the moving parts such as the wheels.

Getting up and down kerbs

This should only be attempted when a carer or attendant are controlling the wheelchair. Carers/attendants should bear in mind that they will be supporting more of the user' s weight when the wheelchair is tipped rearwards and the heavier the user the more weight they will have to support. If there is any doubt that this cannot be supported then seek dropped kerbs or ramps and do not put the user or yourself at risk of injury.

 **The wheelchair should never be tipped forwards as the occupant may fall out.**

Getting up a kerb

First method

- The wheelchair footplates (or, if longer, the user' s feet) should be taken to the edge of the kerb;
- The pusher should hold the wheelchair push handles firmly and tilt the chair back, use one foot on the tipping lever to assist and carefully tilt the wheelchair backwards
- The wheelchair should be brought forward until the back of the wheels touch the kerb;
- The front wheels should be lowered down on the path;
- With the push handles held firmly the attendant should lift and push the wheelchair forward.



Second method

- The wheelchair should be turned around so that the back wheels are against the kerb;
- The attendant should hold the wheelchair push handles firmly and push down with one foot on the tipping lever, tipping the wheelchair backwards balancing it on the large wheels;
- Using his body weight, he should then pull the wheelchair off the kerb and up onto the pavement.



Getting down a kerb

- The wheelchair castors should be taken to the edge of the kerb.
- The attendant should hold the wheelchair push handles firmly and push down with one foot on the tipping lever, tipping the wheelchair backwards balancing it on the large wheels.
- The large wheels should be taken to the edge of the kerb.
- The wheelchair should be lowered slowly down the kerb on its back wheels before the castors are lowered gently down onto the ground.



 **The wheelchair should never be tipped forwards as the occupant may fall out.**

Going down a steep slope

The use of the wheelchair on slopes greater than the maximum recommended may put the user at risk. If such slopes are unavoidable then

- It is safer for the attendant to take the wheelchair down backwards.
- The occupant may be able to help by controlling the wheels or the brakes. (Hub brakes if fitted are more suited for this purpose)
- The user weight will have a significant effect on controlling the wheelchair – the heavier the user the more difficult it will be to control the wheelchair.



5.5 Wheelchair stability

Certain routines and movements may affect the stability of the wheelchair

The following factors can affect the wheelchair stability: -

User body movement

REACHING - BENDING FORWARD	
X	DO NOT lean your body forward out of the wheelchair further than the length of the armrests as this may affect your stability.
X	DO NOT attempt to pick up objects from the floor or to reach out at switches by bending forward or reaching between your knees as this may affect your stability.
X	DO NOT attempt to reach objects by sliding forward to the edge of the wheelchair seat as this may affect your stability.

✓ Leaning forwards when going up slopes can improve the rearwards stability and leaning the upper body uphill when moving across a slope can improve sideways stability.

REACHING - BENDING BACKWARDS	
X	DO NOT reach back any further than your arm will extend without changing your sitting position as this may affect your stability.
X	DO NOT lean over the top of the backrest as it will shift the centre of gravity, risking tipping over.
X	DO NOT hang heavy loads or objects on the backrest. They may make the wheelchair unstable, especially on an incline.

✓ Assistive devices such as grab sticks can be used to reduce the upper body movement. Contact your healthcare specialist for further details.

Body weight proportions

Upper torso weight and height, lower limb amputation, obesity, asymmetrical body positions (leaning to one side) and muscle spasms may affect stability.

Operating environment

Hills, slopes, ramps, sloping pavements, dropped kerbs also affect stability, especially if contact is made with small obstacles on slopes or hitting obstacles. Sloping surfaces should never be attempted sideways. These can cause the user to slide forwards or fall forwards out of the wheelchair.

Accessories or other equipment

Accessories generally affect the stability of the wheelchair. Seat cushions raise the centre of gravity and reduce the stability of the wheelchair in all directions, backrest cushions will move the centre of gravity forwards, which improves the rearwards stability but reduces forward stability. Elevating leg rests fitted onto the front of the wheelchair will reduce the forward stability of the wheelchair.

Anti tip levers

These can be fitted to the rear of the wheelchair to restrict the amount of rearwards tipping that can occur.

Wheel position

The wheels of both the self-propelling wheelchair and the attendant push wheelchair can be adjusted to a rearwards position to improve rearwards stability. This may affect the self-propelling ability because the wheels have been moved further from the arms and shoulders.

Foot propelling

The recommended methods for propelling a wheelchair are: -

Self Propelling wheelchair

- Place feet on footplates and use the hand rims on the wheels to move the wheelchair.

Attendant push/transit wheelchairs

- Place feet on footplates and allow user or attendant to push the wheelchair.

 **Propelling the wheelchair by using the feet is not recommended as your feet may encounter obstacles on the ground and the back of your legs may contact the cross braces underneath the seat. This may also affect the stability of the wheelchair.**

 **If you or your carer/attendant require further advice about stability and its effects then ask your healthcare professional, wheelchair dealer, or wheelchair service for further information.**

6.0 Transporting your wheelchair.

6.1 Lifting a wheelchair into the boot of a car

6.2 Storage in a plane

6.3 Transportability

If the wheelchair is to be transported unoccupied, it may be stored as luggage whilst you are travelling in a vehicle or a plane. The wheelchair may be folded to reduce the space of the wheelchair. Ensure that the wheelchair is properly secured to prevent it moving during transit.

6.1 Lifting a wheelchair into the boot of a car



Where possible ask for assistance

- It is recommended that any detachable parts are removed before lifting the wheelchair
- The folded wheelchair (with armrests and footrests detached, if applicable) should be placed close to and parallel with the car boot.
- The person should grip convenient fixed parts of the wheelchair, one hand well forward and the other well back.
- Keeping their back straight the person should bend hips and knees, straighten their legs and lift up the chair (vertically) and balance it on the edge of the boot.
- With the weight taken by the wheels resting on the edge of the boot, the chair should be tilted towards the person; when nearly horizontal, it can be slid into the boot.



6.2 Storage in a plane

- Ensure that any detachable parts are secured with the wheelchair or separately so they do not get lost during loading and un-loading.
- Inform the airline you a travelling with and follow their instructions with respect to transfer and loading of the wheelchair from one location to another.

When the wheelchair is removed from storage or the luggage area

- Check that the wheelchair has not been damaged during the transportation for example by other unsecured luggage or objects falling onto the wheelchair or by impact damage.
- Ensure that any detachable parts removed are replaced when the wheelchair is put back into use.

6.3 Transportability

Transportability of wheelchairs and users in vehicles

A wheelchair secured in a vehicle will not provide the equivalent level of safety and security of a vehicle seating system. It is always recommended that the user transfers to the vehicle seating. It is recognised that this is not always practical for the user to be transferred and in these circumstances where the user must be transported whilst in the wheelchair the following advice should be followed.

1. Confirm that the vehicle is suitably equipped to transport a passenger in a wheelchair and has access that is suitable for your wheelchair type.
2. We recommend:
 - a) That the wheelchair be secured by a 4-part (webbing) Tie Down Restraint system, conforming to ISO 10542. These restraints generally comprise of 4 individual straps that are attached to each corner of the wheelchair
 - b) That the occupant should be restrained independently of the wheelchair by a lap and diagonal safety belt, conforming to ISO 10542. This is similar to a car seat belt that comes across the user's shoulder and around the waist.
 - c) Any part of the wheelchair accessories such as kerb climbers) that can easily be detached should be removed and stored in the vehicle luggage compartment during transportation.
 - d) The wheelchair should always be transported in the forward facing direction.
 - e) Sufficient space should be available around the wheelchair to enable clear access to attach, tighten and release the wheelchair and occupant tie down restraints and safety belts.
 - f) If other passengers in the vehicle are provided with a headrest the wheelchair user should be provided with a headrest that is suitable for use with the wheelchair in transportation.
 - g) The tie-down restraints should be fitted to the main frame of the wheelchair as indicated in the diagram on the following page, and not to any attachments or accessories, e.g. not around the spokes of wheels, brakes or footrests.
 - h) The tie-down restraints should be attached as close as possible at an angle of 45 degrees and tightened securely in accordance with the manufacturer's instructions.
 - i) Pelvic restraint, posture belts or lap belts supplied with the wheelchair should always be used in addition to, but never as a substitute for the approved passenger restraint belts.
 - j) The safety of the user during transportation depends upon the diligence of the person securing the tie-down restraints and they should have received appropriate instructions and/or training in their use.

The wheelchair should be restrained with 4-point tie down webbing straps, with non-adjustable front straps and adjustable rear straps, which typically use Karabiner clips/S hooks and tongue and buckle attachments.

The attachment points to the chair are the inner front side frame just above the castor and the rear side frame. The straps are fitted around the side frames at the intersection of the horizontal and vertical frame tubes. (See illustration on following page)

The tie down symbol on the wheelchair frame indicates the position of the wheelchair restraint straps. The straps are then tensioned after the front straps have been fitted to secure the wheelchair.

The wheelchair must be facing forward and the manual brakes firmly applied. The wheelchair occupant should be secured using a 3-point double inertia reel belt.



It is recommended that a lap/pelvic belt similar to the example shown previously in the section headed seat belts, be used in conjunction with the vehicle occupant restraints.

⚠ The seat/pelvic belt should never be used in place of the occupant lap and diagonal belt when travelling in a vehicle.

Transportability – positioning of wheelchair tie down restraints on wheelchair



View on the left shows a self-propelling wheelchair secured with front and rear wheelchair tie down restraints. Positioning of the restraint straps is shown in more detail below.

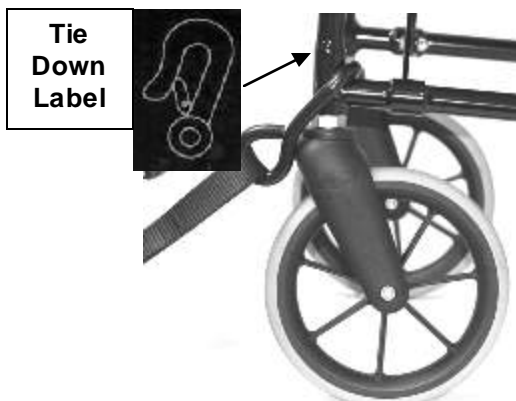

Position of the **front** wheelchair tie down restraint and the tie down label

The position is the same for both the self-propelling Uni 8 Series and the attendant push wheelchairs Uni 9 Series.

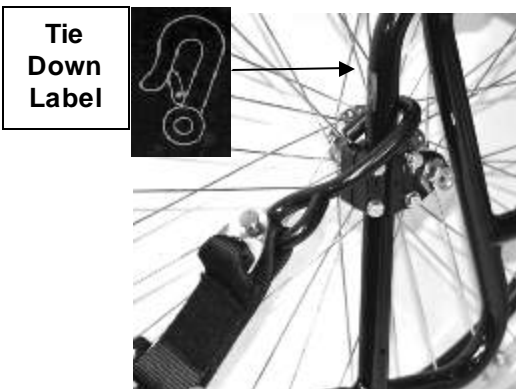

Position of the **rear** wheelchair tie down restraint and the tie down label on the self-propelling wheelchair (Uni 8 Series)

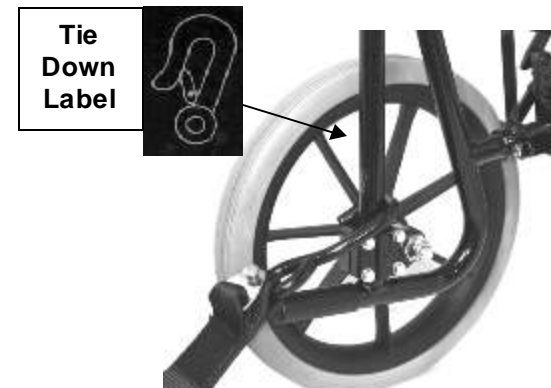

Position of the **rear** wheelchair tie down restraint and the tie down label on the attendant push wheelchair (Uni 9 Series)

7.0 Wheelchair cleaning and maintenance

Your wheelchair is designed to require the minimum amount of maintenance. Your dealer, or repair/contractor, is equipped with facilities, including maintenance and spare parts manuals, to carry out repairs/maintenance to keep the wheelchair and user mobile in the event of a problem or accident.

7.1 Recommended checks

We recommend that users carry out the following checks prior to using the wheelchair

Brakes: -

- Check that the brakes are securely attached and operating correctly.

Front wheels (castors): -

- Check that they are free to rotate, and that the castors swivel freely and are not damaged.
- Check the castor mounting for tightness and play.

Rear wheels: -

- Check that the wheel spokes of any self-propelling wheelchairs are not loose or damaged.
- Check for any flexing or excess movement in the wheels.
- Check the tyre pressures are correct for pneumatic tyres 375Kpa (60psi)

Upholstery: -

- Check the seat and backrest for any damage, tears, cuts, etc. Damaged upholstery may need replacing.
- Check the retaining screws for damage and tightness.

Folding Pivot Points, Footplate Pivot, and Hinge Pins: -

- Occasional (every 12 months) lubrication of pivot points (using Three-in-one oil or similar light oil) will ensure ease of operation.

Handgrips: -

- Check that the handgrips on the push handles are secure and not damaged.

7.2 Cleaning the wheelchair

- If dirty or dusty, the upholstery should be wiped with a damp cloth. Marks may be removed with tepid soapy water.
- If dirty, the paintwork may be cleaned with a damp cloth and the paintwork protected by applying a household polish or proprietary car wax in accordance with the manufacturer's instructions.

7.3 Service and maintenance

We have has issued guidelines on the planned preventative service levels for manual wheelchairs. These guidelines are based on the type of usage that the wheelchair receives in the service period.

The table on the following page showing service frequencies, are recommended but can be revised accordingly following assessment of the user at time of issue (including any risk assessments), use of existing service maintenance/service history records, changes in user circumstances e.g. transportation. If required, we are available to offer further guidance.

User categories and recommended Service Frequency

User Category	Definition	Service Frequency
Attendant Push	Transit wheelchair – indoor use Mainly, occasional shopping mall trips.	5 years
Self propelled	Spoked self propelling wheels, Indoor and outdoor use.	24 Months
Heavy	Active user & included lifestyle on different terrain surfaces	12 Months
Transported and Special Seating	Wheelchair and occupant are transported regularly to school/day centre & subject to clamping effects or where additional forces or clinical fatigue conditions may cause fatigue. Such as spasms, stress relieving.	6 Months

 **If you think there is something wrong with your wheelchair then contact your Healthcare professional or your wheelchair dealer or repair contractor and ask them to check the wheelchair.**

8.0 Optional features and accessories

8.1 Optional armrests

8.2 Adjustable plantar footplate assemblies

8.3 Optional leg rests

8.4 Backrest options

8.5 Seat options

8.6 One-arm propulsion

8.7 Brake options

8.8 Miscellaneous options

The following optional equipment is available and may be fitted to your wheelchair.

If you have any doubt or query when setting up or using these options, please seek help from your healthcare specialist.

8.1 Optional armrests

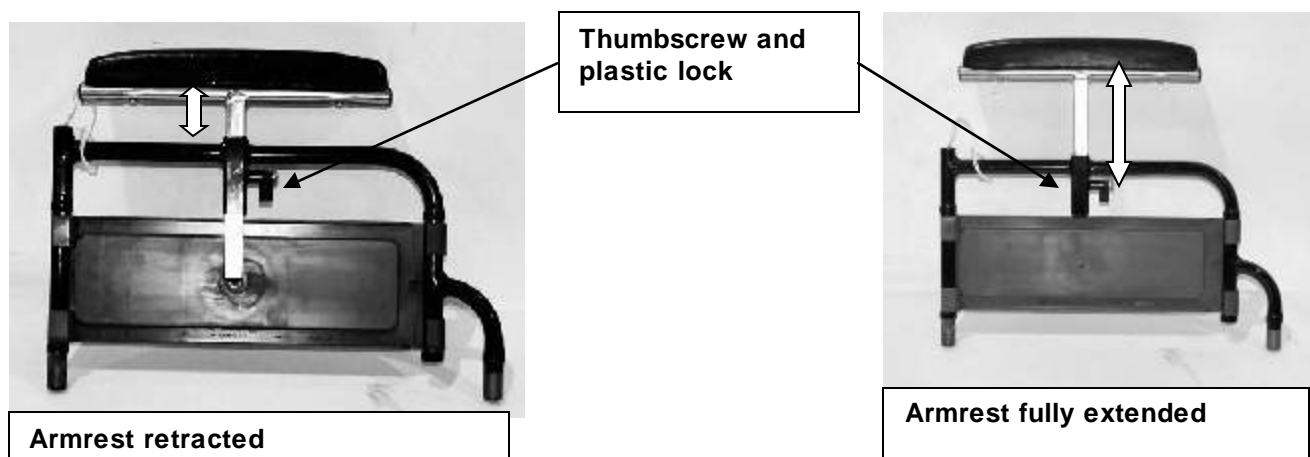

Height adjustable armrest

Height adjustable armrests can be raised or lowered in increments of 25mm (1"). To raise or lower the height adjustable armrest, slacken the thumbscrew and turn the plastic lock to disengage and lift or lower the arm pad. Release the plastic lever lock and allow the latch to engage in the hole. Tighten the thumbscrew.

Out rigged Armrest

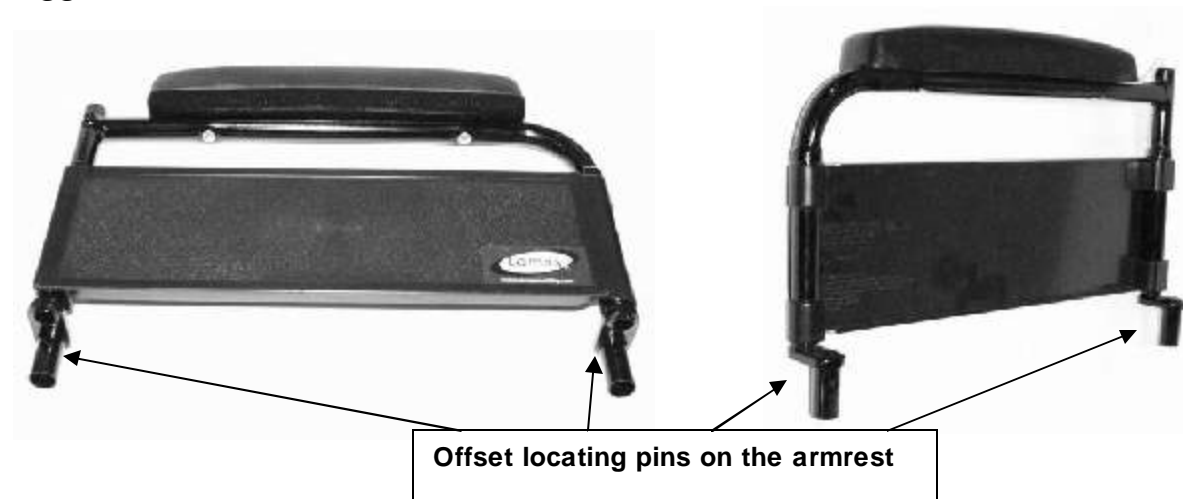

An out rigged armrest is one that has the locating pins offset inwards to allow for the location of the armrest outwards from the seat.

Two inch higher armrest

This armrest is taller for users who are taller in stature.

⚠ The arm pads should be adjusted to their lowest height setting for getting in and out of the wheelchair.



When getting into and out of the wheelchair, it is recommended that the footplates should be hinged up and the brakes should be on.

⚠ Do not stand on the footplates or the wheelchair will tip up.

8.2 Adjustable plantar footplate assemblies

 To adjust, slacken the 3 socket head cap screws, using a 5mm A/F Allen key, set the footplates to the required angle and tighten the 3 screws.

⚠ Both the footplates must be swung outwards when getting in and out of the wheelchair.

⚠ Do not stand on the footplates or the wheelchair will tip up.

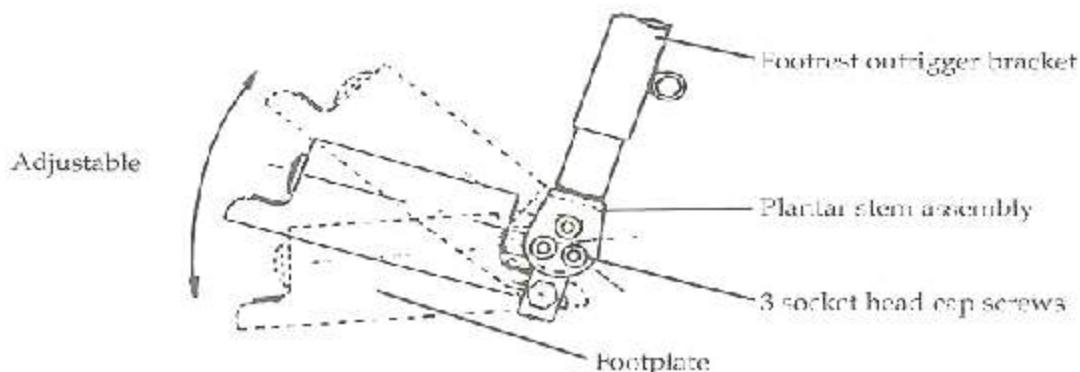

Sketch showing footplate assembled to plantar assembly and installed into footrest outrigger bracket.

8.3 Optional leg rests

Detachable elevating leg rests

These support the whole leg in any desired position and may be adjusted individually for length and elevation. They attach and detach in exactly the same way as the standard footrests.

To raise the leg rest: -

Simply lift it to the desired position where it will lock automatically. To lower the leg rest, press the locking catch situated on the adjusting rod and lower the leg rest to the position you want, and then release the locking catch.

To adjust the calf pad: -

The calf pad is attached to the leg rest by means of a plastic bracket, this bracket allows for the rotation of the calf pad around the leg rest and into position to support behind the calf. When rotated the bracket is secured in place by a spacer bush bolted onto the side of the leg rest, the calf pad can then be swivelled to the desired angle or position to suit the users needs.

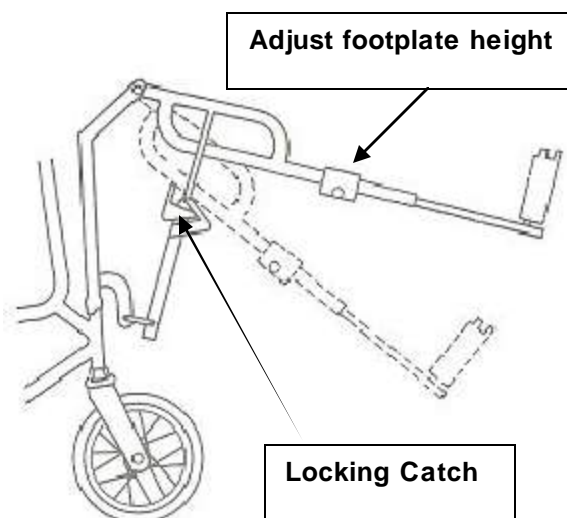

⚠ The stability of the wheelchair will be affected by the use of the elevating leg rest.

⚠ Your healthcare professional should be involved when setting the wheelchair up for your needs. It may be that the wheel position may require some adjustment to help maintain the overall stability of the wheelchair.

EXTRA care must be taken when propelling or pushing a wheelchair with leg rests straight out in front of you because, in the position, the legs may easily be bumped or knocked.

Elevating leg rests

These support the whole leg in any desired position and may be adjusted individually for length and elevation. They attach and detach in exactly the same way as the standard footrests.

To raise the leg rest: -

Simply lift it to the desired position where it will lock automatically. To lower the leg rest, press the locking catch lever situated on the adjusting rod forward and lower the leg rest to the position you want then release the locking catch.



To adjust the calf pad: -

The calf pad is attached to the leg rest by means of a plastic bracket, this bracket allows for the rotation of the calf pad around the leg rest and into position to support behind the calf. When rotated the bracket is secured in place by a spacer bush bolted onto the side of the leg rest, the calf pad can then be swivelled to the desired angle or position to suit the users needs.

Note - the height or location of the calf pad on the leg rest is also adjustable. It is recommended that any adjustments to the calf pad be carried out by suitably trained or qualified personnel.

⚠ See warnings page 32

Articulating Leg Rests (ALR) set up

The ALR is intended for use by a person whose lower leg needs to be supported or elevated. When set correctly, such that the ALR matches the knee bend position of the user, the ALR supports the leg in an elevated position from 0° to 90° and avoids leg extension. The angle can be set by the user to obtain the desired position with the footplate and calf pad supporting the lower leg.

The ALR can be swung to the side to allow access in and out of the wheelchair or it can be removed completely, the calf pad and footplate are adjustable for angle and height.

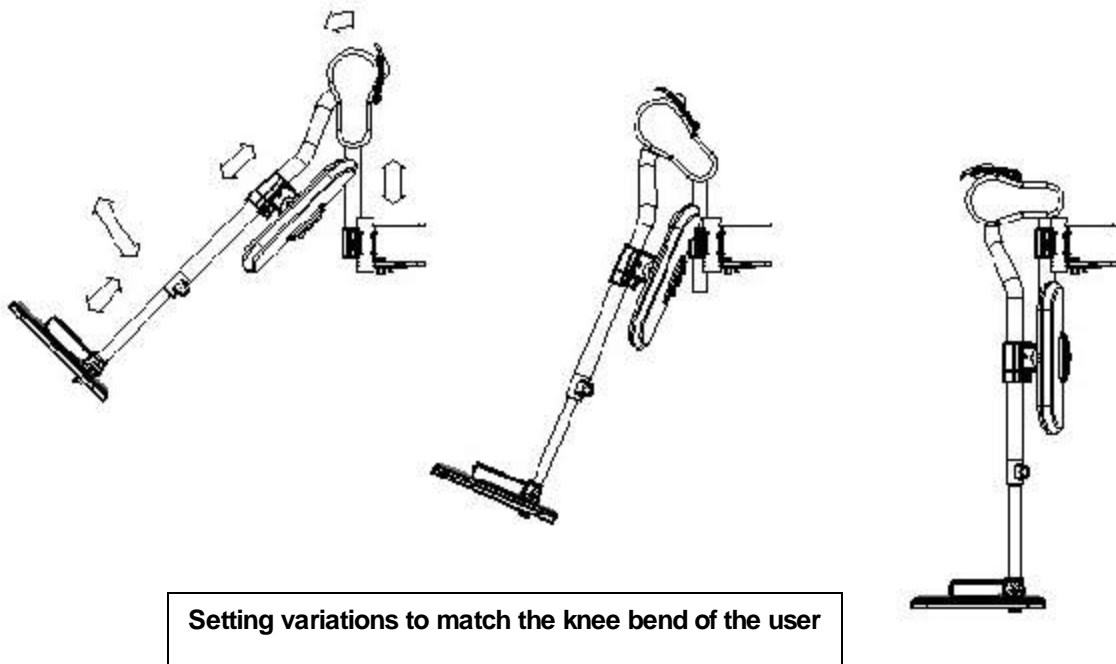

! It is important that the ALR is correctly set to obtain full benefits from it. Setting up instructions are given below. The person supplying/fitting the ALR, or your healthcare professional should set it up and show you how it is used.

 With user in wheelchair and any cushions/reclining backrest/ seat tilt adjusted to suit user, remove existing footrest and fit ALR onto existing footrest mounting brackets, and adjust as follows:

To adjust height of A: -

Slacken button head screws (B), raise or lower stem.

Tighten screws (B) 6-8Nm

Check position of (A). Ensure alignment with user knee pivot point

To adjust angle of pivot arms C: -

Slacken cap head screws (D), rotate stem to desired position

Tighten Screws (D) 6-8Nm

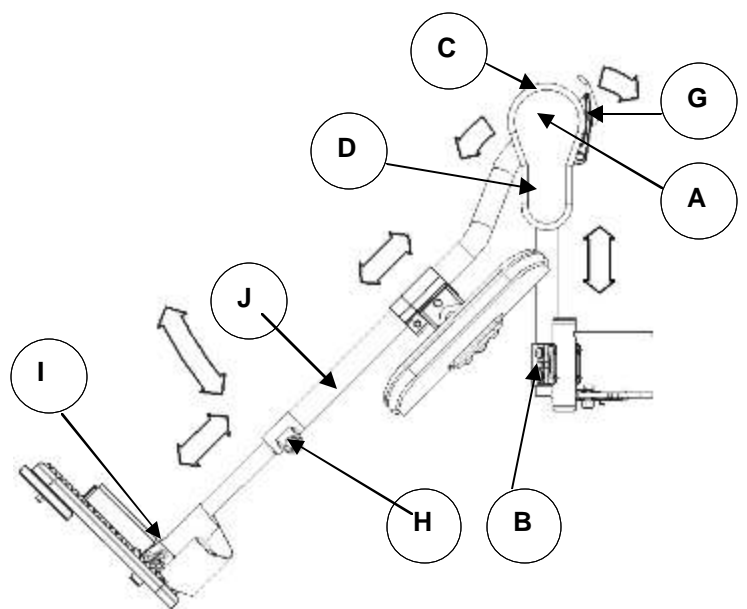

To adjust Calf Pad: -

- Slacken screw on lock collar (F)
- Release Cam Lever (E)
- Move pad to desired position and close lever (E)
- Position lock collar (F) against calf pad bracket (E)
- Tighten lock collar screw (E) 6-8Nm

Calf Pad height adjustment: -

- Undo nut & bolt (E1)
- Raise or lower the calf pad to desired height
- Replace bolt and nut (E1) Tighten bolt & nut (E1) 8-10Nm

To adjust footplate for leg length: -

- Slacken nut (H)
- Raise or lower footplate
- Tighten (H) 12-16Nm

To adjust footplate for angle: -

- Slacken 3 screws (I)
- Rotate footplate to desired angle
- Tighten 3 screws (I) 8-10Nm

To use ALR

- Pull cam lever (G) upwards, raise or lower main stem to desired position
- Push cam lever (G) to lock in position.
- Lift up lever (E) to rotate the calf pad out of the way
- Push down lever (E) to lock in desired position

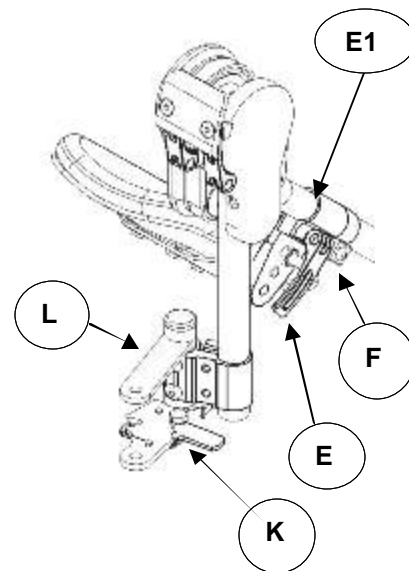



 **See warnings on following page.**

 Warnings ELR and ALRs

 Do' s and Don' ts	
✓	Do ensure correct adjustment – see above
✓	Do ensure that the ELR/ALR is locked to prevent it swinging to the side.
X	Don' t attempt to get in or out of the wheelchair with the ELR/ALR elevated
X	Don' t stand on the footplate when getting in or out of wheelchair– swing ELR/ALR around to side of chair, or swing calf pad and footplate aside.
X	Don' t use with ELR/ALR elevated when the wheelchair and user are being transported and the wheelchair is restrained using a Wheelchair Transport and Occupant Restraints (WTORS)

 Take care to avoid trapping fingers.

 EXTRA care must be taken when driving a wheelchair with leg rests straight out in front of you because, in the position, the legs may easily be bumped or knocked or other pedestrian users may come into contact with the extended leg rest.

 The ELR/ALR should be returned to the non-elevated position when encountering steps, kerbs, ramps and any changes in slopes.

 Use of the ELR/ALR in an elevated position may affect the stability/balance of the wheelchair. Reduce speed accordingly and avoid sudden changes of direction.

 Users attempting to use the wheelchair beyond the manufacturer' s recommendations may put themselves at risk of serious injury or even death

Ask the person supplying the ELR/ALR/wheelchair or your healthcare professional for further advice

Trans Tibial Supports (Stump supports)

They attach and detach to the wheelchair in exactly the same way as the standard footrests.



To raise or lower the support pad: -

Slacken the clamp screw and raise or lower the support pad to the desired position. Tighten the clamp screw securely.



The use of the support may affect the stability of the wheelchair.

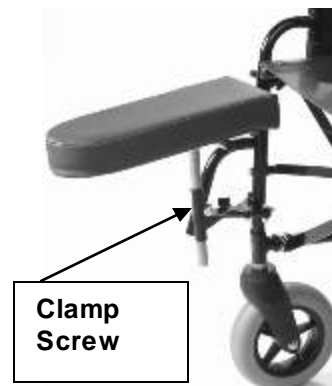

8.4 Backrest options

Backrest extension

The extension is fitted onto bobbins that replace the existing upper backrest retaining screws.

To fit the extension: -



Unscrew the bolts that secure the current backrest canvas, replace these with the bobbins and screw in place. The backrest extension contains two machined slots, for attachment onto the two bobbins. See photo to the right. Place slots on support tubes over the bobbins and push down firmly.

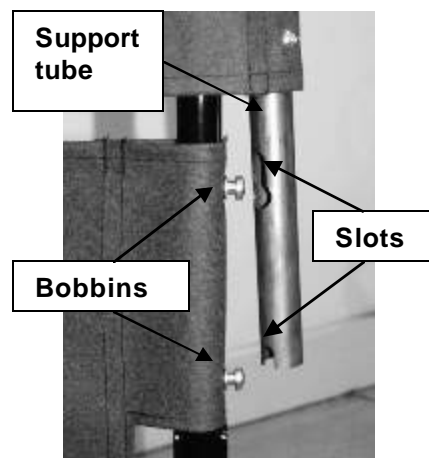

To remove the extension: -

Partially fold the wheelchair, lift the support tubes on the extension upwards and remove from the backrest.



Tension adjustable backrest

The existing backrest can be replaced with a tension adjustable backrest. The tension can be adjusted by adjusting the length of the straps to increase or decrease the amount of free play in the backrest. Release the free end of the strap from the Velcro and pull back through the buckle to increase the backrest free play or pull more of the strap through the buckle. To tighten the strap and reduce the backrest free play, ensure when adjusting that the straps are fed back through the buckles and secure – attach free end to Velcro. It is recommended that a comfort strut be used with a tension adjustable backrest to maximise benefit.



Backrest tensioner (comfort strut)

This consists of a centrally hinged bar that when opened keeps the backrest/push handles apart from pulling in when the user is seated. (It is sometimes known as a comfort strut)

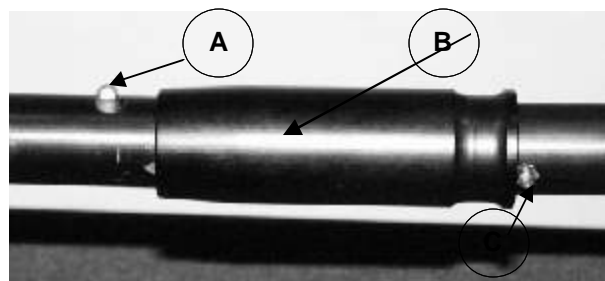

To fold the wheelchair with tensioner fitted: -

Ensure user is not sitting in wheelchair. Push pin A on the bar (at the opposite end of the grooved sleeve) inwards and slide sleeve (B) over the pin. Remove solid seat board if fitted. Push bar down and fold wheelchair.



Folded

To open or unfold the wheelchair: -

Grip bar either side of hinge to unfold the wheelchair. Lift bar upwards (grip either side of hinge) Slide sleeve along over spring pin (A) and hinge to stop pin (C).

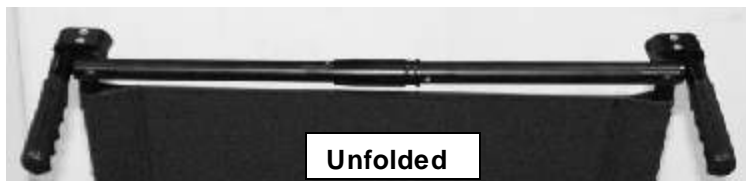

Unfolded

Domed 9" removable backrest extension

The domed headrest can be fitted by sliding onto the two spindles located on the inside of the backrest. To remove lift the domed headrest off the spindles, the domed headrest must be removed before the wheelchair can be folded. This feature comprises an extended headrest to provide upper back and head support for the taller user, the headrests come in a selection of sizes.



Domed Headrest

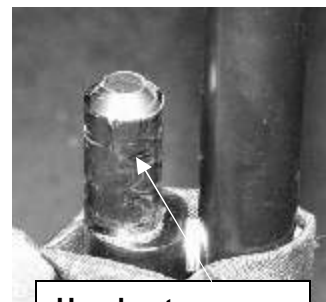

Headrest locating spindle

8.5 Seat options

Solid seats

To remove the seat: -

Remove the left hand armrest and lift the left hand side of the seat up. Pull the seat to the left and remove from the right hand seat rail; the wheelchair can then be folded.

To replace the seat: -

Unfold/open the wheelchair fully and remove the left hand armrest. Slide the right hand side of the seat onto the top of the right hand seat rail.

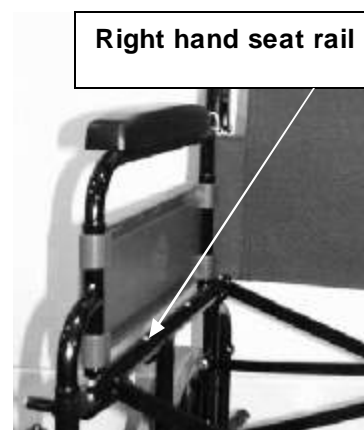

The U shaped brackets under the seat on the right hand side should locate on the right hand seat rail.

Push the left hand side of the seat down onto the left hand seat rail slot allowing the slot in the bracket on the left underside to locate in the cross brace stay

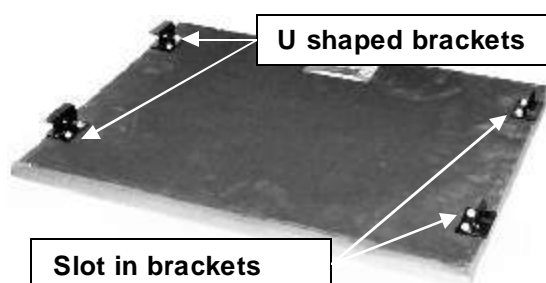

Note: left and right hand sides are mentioned in above are as viewed when sitting in the wheelchair. Ensure seat board is located on top of seat rails securely and not between seat rails.

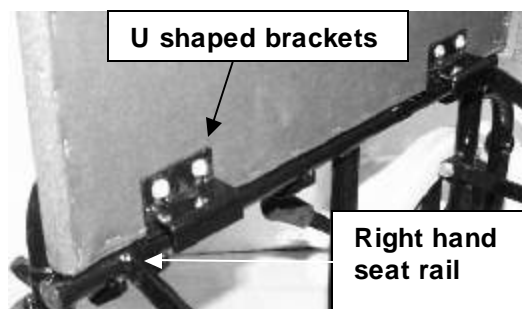

Cushions

Your wheelchair may be supplied or fitted with a cushion. These come in a variety of types and sizes.

Always ensure that the cushion is properly fitted into the very back of the seating space.

 **Using a cushion raises the seated position and may reduce the stability.**

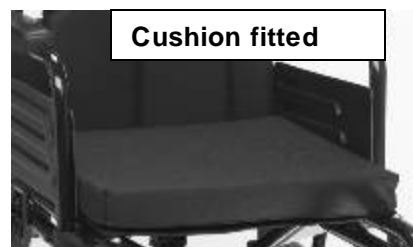

Height adjustable handles

 The push handle height can be adjusted as follows: - Pull the release clamp (1) away from the push handle to release the clamp and slide the push handle (2) up or down to the desired position. To lock the push handle push the release clamp firmly towards the push handle to lock it. On completion ensure that the clamping lever are tight and the push handle secure. The push handles may be removed completely by release the clamps and sliding the push handle upwards and depressing the pins (3) to allow them to pull through the bracket. To refit reverse the above procedure

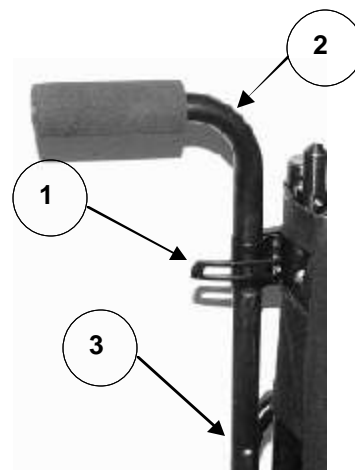

The push handles can be rotated outwards to an angle of 45 degrees to make pushing slightly easier.

8.6 One-arm propulsion

This enables those with one disabled arm or hand to propel and guide the wheelchair with the other arm. Two hand rims, one smaller than the other are placed on one side of the wheelchair (the good arm side). When both hand rims are grasped together the wheelchair may be moved forwards or backwards in a straight line.

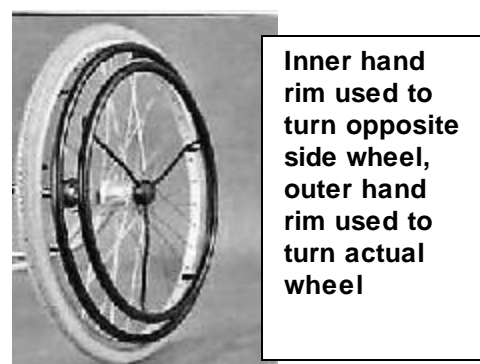

Right Arm Drive Wheelchair

- To turn left, use inner hand rim
- To turn right, use outer hand rim

Left Arm Drive Wheelchair

- To turn to the left, use outer hand rim.
- To turn to the right, use inner hand rim.

Always seek help when setting up the device.

To remove: -

The one arm drive shaft can be removed by holding the shaft at one end, grip the opposite end of the shaft and compress the shaft inwards towards the held end removing the drive socket of the shaft from the wheel axle. Pull the shaft rearwards and outwards to remove from the opposite wheel.

To fit: -

 Locate one drive socket onto the wheel axle. Grip the opposite end securely and compress the drive shaft inwards towards the opposite end by about 50mm (2"). Locate the compressed drive sockets onto the remaining wheel axle and release the grip on the drive shaft. Check that the drive shaft is fully and securely located on the wheel axles and that drive is transmitted from one side to the opposite wheel.

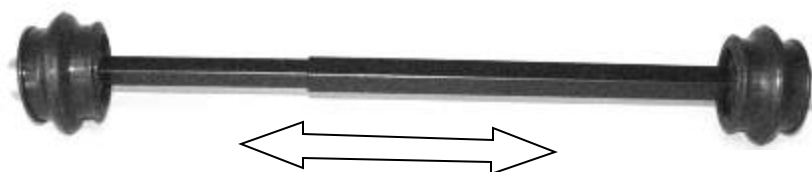

Drive Shaft

⚠ The drive shaft contains a strong spring and no user serviceable parts. Do not compress the drive shaft and allow to release suddenly.

Quick release self-propelling wheels

Your wheelchair may be fitted with either fixed or quick release wheels. Quick release wheels can be removed from the wheelchair to make it lighter for lifting and easier to store.

To remove wheel: -

Press the button (1) in the centre of the wheel and slide the axle and wheel out of the axle bush fully.

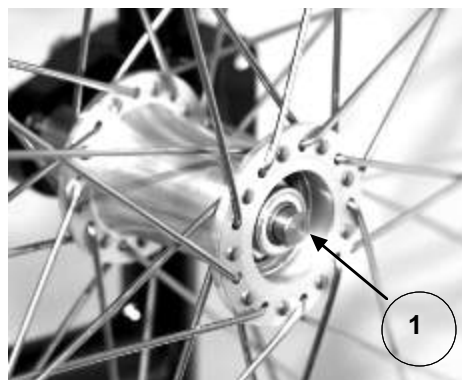

To replace wheels: -

Reverse the above procedure and depress the centre button of the axle and push the exposed axle into the wheel bush. When the axle/wheels are fully inserted release the centre button.

Check that the button is fully released and that the wheel is secure in the axle bush by pulling the wheel gently away from the wheelchair. The wheel should remain in the same place.

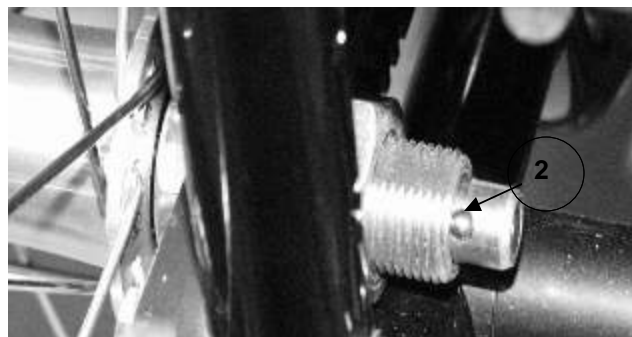

⚠ Always ensure that the quick release wheels are fully engaged with the locking ball bearings (2) on the axle shaft fully engaged and visible on the inner side of the axle bush.

⚠ Never mount the quick release rear axles with the release button positioned inside the frame. This will cause the wheels to release when the chair is folded.

⚠ Do not alter the position of the wheels in the wheel mounting blocks without the approval of the person prescribing the wheelchair.

8.7 Brake options

Hub Brakes

The fitting of a hub wheel brake to the rear wheels, allows an attendant or carer to have enhanced control of the wheelchair when it is being pushed. Hub brakes can be used to slow the wheelchair down whilst in motion or control the movement while on an uphill or downhill slope, as well as being used as a parking brake when the wheelchair is stationary. The operating lever allows the brakes to be applied gradually or fully. When applied a self-locking mechanism on the lever keeps the brake held in the ON position. The position of the operating levers on the push handles generally restricts their operation to an attendant or carer and is independent of the user. The operation of the Hub brakes is independent of tyre wear and pressure, provided these are maintained correctly.

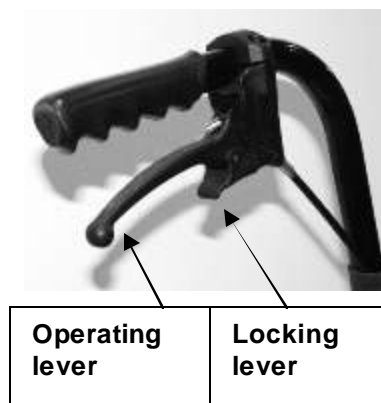

To apply the brakes: -

Squeeze the operating lever on each push handle until the motion of the wheelchair is slowed or stopped. This allows the locking lever to lock the lever and release the operating lever.

To disengage the brakes: -

Squeeze the operating lever and flick back the release lever gently, releasing the operating lever.



Only release brakes completely on flat or level ground.

8.8 Miscellaneous options

Anti tip levers

Anti tip levers can be fitted to restrict the wheelchair from tipping backwards. They are fitted onto the existing tipping levers at the rear of the wheelchair.



They can be adjusted for height by turning the lock lever and raising or lowering the tube with the wheels fitted in increments of 25mm (1"). When the desired position has been reached then release the lock lever and ensure that it engages in the nearest hole and locks the tube.

 **Seek advice from your healthcare professional on this issue.**

 The position of the wheels can also be changed, by moving them to one of the other two alternative positions.

Remove the securing screws and repositioning the wheel to an alternative position. Replace the screws and tighten to 6-10Nm.

 **The anti tip levers may need to be raised when climbing kerbs.**

 **The use of anti tip levers may also affect wheelchair stability.**

Table trays

(not suitable for use with Unilite armrests)

The armrest of the wheelchair can be reversed from front to back and swapped from left to right to allow a table type tray to be fitted into the rear armrest vertical tube.

To fit the tray mounting tubes reverse the armrests as above, pull the cord to remove the rear plastic plug from the armrest socket. Insert the tray tubes into the vertical armrest tubes. A thumbscrew can be fitted into the nut on the vertical tube of the armrest to allow the tray-mounting bracket to be lowered or raised.

The thumbscrews under the tray allow it to be moved forward and backwards. Tighten all thumbscrews securely after slackening.



Table tray



Fitted tray

 **Trays should only be used when the wheelchair is static and the brakes applied.**

 **The use of trays may also affect wheelchair stability.**

 **Seek advice from your healthcare professional if you feel the device is unstable in any way.**

Oxygen Bottle Holder

This allows a small oxygen bottle to be fitted to the rear of the wheelchair to provide the occupant with an oxygen supply.



⚠ Safety note for prescribers and users

A risk of imbalance due to the cylinder weight may exist.

A potential risk of fire may exist.

A stability test and risk assessment should be carried out by the prescriber.

The following checks should be made before using the wheelchair: -

- Check that the oxygen cylinder is securely attached.
- Check that the oxygen line is not fouling or touching any moving parts of the wheelchair, such as the wheels.
- Check the condition of the oxygen tubing.

The oxygen source should be turned **OFF** when not in use.

The oxygen bottle and contents should be used only for the purpose of providing oxygen for the user.

- Check that the oxygen cylinder has sufficient oxygen for any use planned including return journeys.

⚠ The user and carer should not smoke in the presence of the oxygen bottle.

⚠ The carrying and use of an oxygen bottle will affect the stability of the wheelchair.

⚠ If the wheelchair is to be transported, the oxygen bottle should be removed and stored appropriately within the vehicle. Seek advice from your healthcare professional.

Crutch Holder

The crutch holder provides a storage location for crutches and walking sticks. The sticks and crutches should be placed in the holder and secured with the Velcro tie at the top

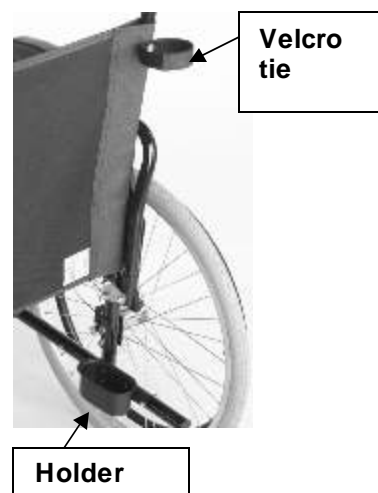

⚠ Always ensure that any items stored in the crutch holder are made secure.

⚠ These may affect the stability of the wheelchair seek advice from your healthcare professional.

9.0 Disposal / recycling of materials

 **If the wheelchair has been supplied to you free of charge it may not belong to you. If it is no longer required follow any instructions given by the organisation issuing the wheelchair in order that it may be returned to them.**

The following information describes the materials used in the wheelchair in relation to their disposal or re-cycling of the wheelchair and its packaging.

Specific waste disposal or recycling regulations may be in force locally and these should be taken into consideration when disposal arrangements are made. (This may include the cleaning or de-contamination of the wheelchair before disposal.)

Aluminium: - castor forks, wheels, footplates,

Steel: - Main side frames, armrests, leg rests, push handles, fasteners.

Plastic: - Handgrips, tube plugs, seat location brackets, castor wheels and tyres

Packaging: - Low density polythene bag, cardboard box

Upholstery: - woven polyester with PVC coatings and expanded combustion modified foam

Disposal or recycling should be done through a licensed agent or authorised place of disposal. Alternatively your wheelchair may be returned to your dealer for disposal.

10.0 Warranty

We recommend that your Repair Contractor/ Dealer regularly service your power chair.

Your wheelchair is provided with a manufacturer' s warranty covering the following parts: -

- The frame is covered for manufacturing/material defects for a period of 5 years.
- All other parts are covered for 12months (Warranty is effective from date of despatch)

The warranty is subject to the following conditions: -

- It does not apply to wear and tear, inappropriate or incorrect use, or non-observance of User Instructions.
- Defective set up by the user or third parties or negligent or careless treatment.
- Use of unsuitable or unapproved spares or unauthorised alteration.
- The warranty does not extend to consequential costs resulting from fault clearance, loss of earnings or expenses.

Life Expectancy:

We estimate a life expectancy of 5 years for this product, provided that:

- It is used in strict accordance with the intended use as set out in this document
- All service and maintenance requirements are met

The estimated life expectancy can be exceeded if the product is carefully used and properly maintained. The life expectancy can also be considerably reduced by extreme or incorrect usage. The fact that we estimate a life expectancy for this product does not constitute an additional warranty.

11.0 Wheelchair dimensions

The overall dimensions are shown below. (Note: All dimensions are nominal.)

Seat Widths	13"	14"	15"	16"	17"	18"	19"	20"
Uni 8								
Mm	552	578	603	628	654	679	705	730
in	21.7	22.7	23.7	24.7	25.7	26.7	27.7	28.7
Uni 9								
Mm	495	521	546	572	597	622	648	673
in	19.5	20.5	21.5	22.5	23.5	24.5	25.5	26.5

Seat Depth	15"	16"	17"	18"
Uni 8				
Mm	970	995	1020	1046
in	38.2	39.2	40.2	41.2
Uni 9				
Mm	914	940	965	990
in	36	37	38	39

The wheelchair size should suit your needs in terms of the seat width and seat depth. If in doubt consult your healthcare professional or the wheelchair prescriber or the wheelchair dealer.

12.0 Wheelchair specification

12.1 Uni Series Specification

Armrests	Detachable
Upholstery	Grey
Brakes	Wheel Lock type
Castors	190mm Diameter
Wheels	Uni 8 - Fixed 560 mm (22") pneumatic Uni 9 - Fixed 315 mm (12.5") Solid
Push Handles	Fixed 36.5" ground to handle
Footrests	Swing away removable
Backrest Height	440mm (17")

Maximum Dimensions	Uni 8
Push Handle height	927mm
Folded length	825mm
Folded width	330mm
Folded Height	790mm
Seat plane angle	5°
Seat height at front edge	482mm 19"
Backrest angle	25°
Footrest to seat distance	320 -470mm
Leg to seat surface angle	103°
Armrest to seat distance	220mm
Hand rim diameter	480mm
Minimum turning radius	850mm

NOTE: - The above dimensions are nominal sizes.

12.2 Identification of UNI wheelchairs.

UNI model codes U8H and U9H are rated at 133Kg (21stone). UNI model codes U8, UL8, U9, UL9 are rated at 115Kg (18stone). Side frames are different as shown below.



Uni 8 115Kg



Uni 9 115Kg



Uni 8 for 133Kg



Uni 9 for 133Kg



UNI 8/9 115Kg – 3 seat support saddles (2 at front, 1 at rear)



UNI 8/9 133Kg – 4 seat support saddles (2 at front, 1 at rear 1 in centre)

HEALTHCARE AUTHORITY DETAILS

REPAIR CONTRACTOR

Due to our policy of continuous improvement in the design of our wheelchairs, product specifications may vary slightly from the examples illustrated.

All weight/dimensions and performance data are approximate and provided solely for guidance.

CE Sunrise Medical complies with the EU Medical Devices Directive 93/42/EEC amended by 2007/47/EEC

All wheelchairs must be used in accordance with the manufacturer' s guidelines.

Sunrise Medical Ltd
High Street
Wollaston
West Midlands
DY8 4PS

Tel: - 01384 446622
Fax: - 01384 446644

Web: - www.Sunrisemedical.co.uk

Part no 25635

