

*Manual Wheelchair User Manual*

**STAR / STAR 2 Series**

( KM-1504 / KM-1514 )



STAR



STAR2



## GENERAL WARNING

- DO maintain your wheelchair well, in particular check the tyre pressure since this affects the efficiency of the brakes. For the correct tyre pressure, please see the walls of the tyres.
- DO make sure both brakes are applied before getting in or out of the wheelchair.
- DO make sure both brakes are applied when the wheelchair is not being pushed or used.
- DO take care when climbing kerbs or turning on slopes.
- DO avoid steep or uneven surfaces that may cause the wheelchair to tip over.
- DO avoid soft surfaces as the casters may become bogged down.
- DO travel smoothly in all conditions.
- DO look well ahead to anticipate hazards such as furniture, doors, potholes, etc.
- DO make sure that both feet are safely on the footrests and that clothing is safely tucked out of the way so that it cannot get caught in the wheels.
- DO take care when traveling up or down or across inclines.
- DO keep both hands on the push handles to control the wheelchair, if you are the attendant.
- DO pay attention to keep the wheelchair balanced.
- DO check the frame and components regularly and refer to this user guide during and after the warranty period.
- DO tie-up the upholstery or replace which with a new one when it becomes loose.
- DO lubricate bearings regularly.
- DO equip with anti-tippers to avoid falling backwards.
- DO equip with a seat belt designed for disabled people.
- DO equip with "heel loops" for disabled people.
- DO clean both hands after oiling the wheelchair.
- DO keep far away from flame
- DO NOT overload the wheelchair in any circumstance.
- DO NOT hang anything heavy on the back of the wheelchair that could cause the wheelchair to become unstable, particularly when negotiating inclines.
- DO NOT allow more than one user at a time.
- DO NOT use with an unconscious patient.
- DO NOT use other transport to pull the wheelchair.
- DO NOT do "wheelies", since you might fall or tip over backwards and suffer a severe injury.
- DO NOT sit in the wheelchair within a moving vehicle unless it has been affixed the labels of hook mark. The labels of hook mark mean that the wheelchair fulfils the performance requirements for a "Crash Test" of ISO 7176-19 and is suitable to use as a seat in vehicles that have been adapted for this purpose.

### WARNING:

- As of this date, KM-1504 has NOT been tested for safety in collisions according to ISO 7176-19. Therefore, KM-1504 cannot be used as seats in any vehicles.

- DO NOT go too fast or turn too quickly.
- DO NOT stand on the footplates when getting in or out of the wheelchair.
- DO NOT go down steps forward, whether solo or with an attendant.
- DO NOT attempt to lift the wheelchair by any removable (detachable) parts. Lifting by means of any removable (detachable) parts of the wheelchair may result in injury to the user and/or assistant or damage to the wheelchair.
- Do NOT use the wheelchair when the back is folded. This alters the centre of gravity and may cause the wheelchair to tip backwards. The back should only be folded for storage or transport of the wheelchair.
- DO NOT hang anything on the back joint that could cause the backrest folding suddenly and may cause injury.

## **YOU AND YOUR KARMA SERVICE PROVIDER**

- No tools are required for assembly. Your wheelchair should be assembled by your authorized KARMA dealer. Your authorized KARMA dealer is also your service provider. Unauthorized repairs, upgrades and add-ons will void your warranty. Anything wheelchair related that requires tools should be done by your authorized KARMA service provider. Your KARMA service provider has the necessary service/maintenance manual for your wheelchair.
- If you have any defective parts or lose any parts, please contact your dealer for repair and/or replacement. Please only use parts authorized by KARMA. Use of parts that are not authorized by KARMA will void your warranty.
- Part numbers are listed on our bill of materials (explosion drawings), which we give to our authorized dealers and service providers. Customers should order parts through their dealer as well as all repairs and scheduled maintenance.
- Customers should go to their dealership for all service needs to guarantee their warranty is not void. Always go to an authorized service provider. Unauthorized repairs will void your warranty. Procedures other than those described in this manual must be performed by a qualified technician. They also have the service manual with a complete list of maintenance required to keep your KARMA wheelchair in top performance. Check the warranty section of this manual to find out what KARMA guarantees and what maintenance service and parts that are not covered by the warranty.
- KARMA does not have an official list of service providers at this time. Please contact your dealer for service. If you cannot contact your dealer, please contact another authorized KARMA dealer for service. If all else fails, contact KARMA directly via our website or give us a call and we can refer you to your new service provider.

## CE MARKING

- This wheelchair complies with the requirements of the Medical Devices Directive 93/42/EEC.



### CAUTION:

- When prescribing wheelchairs for use by full or partial amputees (above or below knee, single or double) or other conditions that affects the user's natural center of gravity and might cause the wheelchair to tip or the person on the wheelchair to fall off, we suggest contacting your therapist or dealer as well as attaching anti-tippers, pelvic belt, or other additional safety accessories.
- When using the wheelchair, ALWAYS follow the Highway Code or your local traffic regulations when outdoors and the guidelines written in this manual.

# TABLE OF CONTENTS



1. PREFACE.....	1
2. SAFETY.....	1
2.1 Doorways .....	1
2.2 Leaning.....	2
2.3 Negotiating Inclines .....	2
2.4 Kerbs.....	2
2.5 Stairs .....	3
2.6 Streets .....	3
2.7 General .....	3
2.8 Upholstery.....	4
2.9 Anti-tippers.....	4
2.10 Maximum User Weight Limit.....	4
2.11 Avoid General Misuse .....	4
2.12 Labeling .....	6
3. INTENDED USE & PARTS.....	7
3.1 Intended Use.....	7
3.2 STAR with with 24" Rear Wheel Parts Description.....	8
3.3 STAR 2 with 24" Rear Wheel Parts Description.....	9
3.4 STAR 2 with 14" Rear Wheel Parts Description s.....	10
4. OPERATION.....	11
4.1 Preparing For Use.....	11
4.2 Transferring In and Out.....	15
4.3 General Use .....	17
4.4 Storing .....	21
4.5 Transportation.....	21
4.6 Pelvic Belt (Option) .....	24

5. INSPECTION AND MAINTENANCE.....	25
5.1 Daily Check .....	25
5.2 Regular Maintenance Record .....	26
6. OPTIONS AND ACCESSORIES.....	28
7. TROUBLESHOOTING.....	28
7.1 Trouble or Problems with Your Wheelchair.....	28
8. SPECIFICATIONS.....	29
9. CLEANING & RECYCLING.....	30
9.1 Cleaning .....	30
9.2 Post-Consumer Recycling .....	30
10. WARRANTY.....	31
10.1 Serial Number.....	31
10.2 Warranty Policy.....	31

# 1. PREFACE

Please carefully read this owner's manual before using the wheelchair. Improper use of the wheelchair could result in harm or injury. Therefore, for safe and enjoyable use of the wheelchair, please read this owner's manual.

- 1.1 This owner's manual includes operation instructions for the aspects of the wheelchair, unfolding/folding instructions and instructions on how to deal with possible accidents.
- 1.2 This owner's manual is written for KARMA wheelchair: STAR Series.
- 1.3 The symbols used in this manual are explained below. Pay special attention to the parts marked with these symbols.

 <b>WARNING:</b>	Improper use could lead the user to severe injury or death.
 <b>CAUTION:</b>	Improper use could lead the user to severe injury and/or damage to your wheelchair.
 <b>SUGGESTION:</b>	Follow these instructions to keep the wheelchair in good condition.

- 1.4 This manual includes the repair and maintenance chart as well as the warranty.
- 1.5 If someone else uses the wheelchair, make sure that you give him or her this owner's manual for his or her reference.
- 1.6 As designs change, some illustrations and pictures in this manual may not correspond to the wheelchair that you purchased. We reserve the right to make design modifications without further notice.

## 2. SAFETY

### 2.1 Doorways

The safest way to operate the wheelchair is on level floors that are free of obstacles. Whenever possible use a ramp to enter or exit a facility. Keeping your hands on the push rims will allow you to maintain maximum balance. Do not try to force yourself over an obstruction by propulsion and never use the sides of a doorway to pull yourself through a passageway.

## 2.2 Leaning

Do not lean over the side of your wheelchair since such an action may cause you to lose balance and fall. (See Figure 2.1)

## 2.3 Negotiating Inclines

2.3.1 Never turn on a hill due to the danger of tipping.

2.3.2 When assisting, go straight up a slope. If user needs to go down midway, walk backwards until user is on level ground (See Figures 2.2 and 2.3)

2.3.3 Do not drive up to 7 degrees of incline to avoid danger. When negotiating inclines, don't propel up to 3 degrees of incline diagonally.

2.3.4 Avoid stopping on an incline, it can potentially cause you to lose control of the wheelchair.

2.3.5 Do not use the brakes to slow down or stop the wheelchair, this could cause it to seize up, causing you to lose control or fall out of the wheelchair.

2.3.6 Whenever possible, utilize help from an assistant/attendant while negotiating inclines.

### CAUTION:

- Although the product has met ISO 7176-1 requirements, we still recommend you not to across a slope (in any direction) greater than 7 degrees. If your daily activities have to across slopes, we suggest you purchase and install anti-tippers to increase the stability of the wheelchair.

## 2.4 Kerbs

2.4.1 Whenever possible get help from an assistant/attendant (if you have assistance make sure that your chair is equipped with push handles)

2.4.2 Avoid hard impacts when descending a kerb. A hard impact could adversely affect the wheelchair.

2.4.3 Never try to scale or descend kerbs that exceed a normal height.

2.4.4 Always take care when climbing kerbs or turning on slopes and never move in reverse without an assistant.



## 2.5 Stairs

2.5.1 Always use two or more assistants. Tilt the wheelchair to its point of equilibrium. One assistant (at the back) holds the wheelchair up against the first step, gripping the handles firmly to lift. The second assistant, holding firmly a fixed part of the front frame, lifts the wheelchair above the stairs and holds it while the first attendant places one foot on the following step and repeat the operation (See below Figure)

2.5.2 Never go down steps forwards.

2.5.3 Never use an escalator for transport, use an elevator.



## 2.6 Streets

2.6.1 Always use extreme caution when crossing streets. Reflective tape on the wheelchair and/or your clothing will make you more visible to drivers.

2.6.2 Please comply with traffic safety code.

2.6.3 Avoid potholes and rough terrain that might cause the casters to become stuck.  
(See Figure 2.4)

## 2.7 General

2.7.1 The expected service life of the product is **five years**, presuming that the product is used daily in accordance with the safety operation instructions, inspection and maintenance instructions, and intended use, which described in this manual.

2.7.2 Always make sure BOTH brakes are applied before getting in or out of the wheelchair.

2.7.3 Never stand on the footplates when getting in or out of the wheelchair.

2.7.4 Never carry more than one passenger. KARMA wheelchairs are limited to one

user.

2.7.6 Use caution to assure your clothing doesn't get tangled with the wheels.

2.7.6 When the user is operating the wheelchair using the pushrim, please push the wheelchair gently. DO NOT apply a sudden huge force on the pushrim. It could cause the chair to tip over. Please refer to the figure below for the best grip points for using the pushrim.

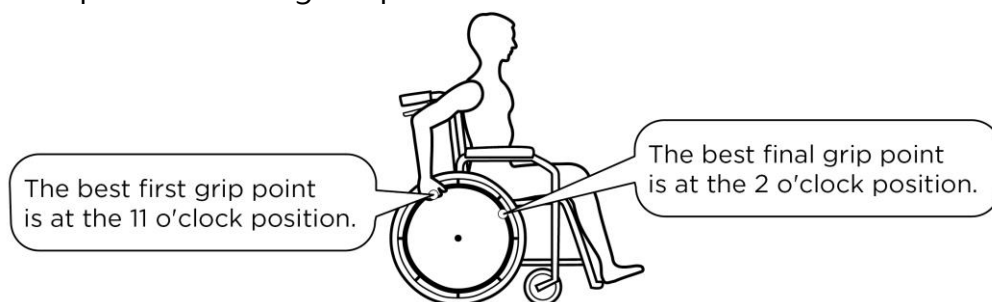

## 2.8 Upholstery

2.8.1 When cleaning the upholstery, use warm water and a mild soap.

2.8.2 Upholstery cleaner/foam can also be used, but avoid other cleaning solvents.

2.8.3 Do be far away of flame, it might injury user and damage the wheelchair.

## 2.9 Anti-tippers

Please strongly consider purchasing anti-tippers and always use them to avoid personal injury. The distance between anti-tipper and wheels is at least 5cm; the height to floor doesn't be over 5cm.

## 2.10 Maximum User Weight Limit

Refer to " Weight capacity " in Section 8. SPECIFICATIONS. Loads exceeding maximum capacity can damage your wheelchair and cause malfunctions yielding a safety hazard. The warranty does not cover damage caused by improper operation of the wheelchair.

## 2.11 Avoid General Misuse

2.11.1 Please note that our "Owner's Manual" contains a number of cautions -- any vehicle can cause injury if misused -- use within our guidelines and with reasonable care and your safety will be increased. Your wheelchair will give years of safe use if used sensibly and carefully. Be aware that careless use endangers

your own safety as well as that of others. ALWAYS follow the Highway Code when outdoors and the guidelines written in this manual.

2.11.2 Do not let children stand or play on the wheelchair. (See Figure 2.5)



Figure 2.1



Figure 2.2



Figure 2.3



Figure 2.4



Figure 2.5

## 2.12 Labeling

Please carefully read all the labeling on the wheelchair before driving it. Do not remove them. Protect them for future reference.

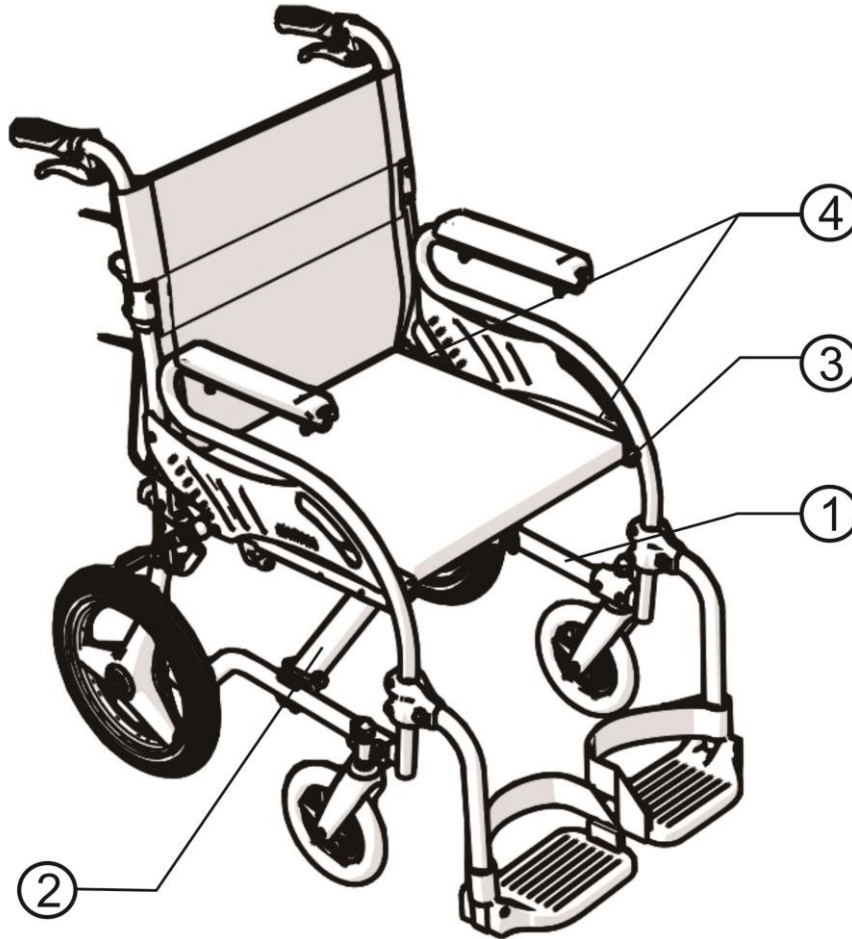

**1**

<b>karma</b>		CE
KARMA MOBILITY, S.L.		
EC REP	C/ PERIODISTA FRANCISCO CARANTONA DUBERT, 23 Bajo 33209 GJÓN - ASTURIAS/SPAIN	
	Tel: (+34) 984 3919107 E-mail: karma@karmamobility.es	
	<b>KARMA MEDICAL PRODUCTS CO., LTD.</b>	
	NO. 236-3, SEC. 2, UNIVERSITY RD., MIN-HSIUNG-SHIANG, CHIA-YI HSIEN, TAIWAN R.O.C.	
<b>WARNING! USE ONLY ON STABLE SURFACES</b> <b>MAXIMUM USER WEIGHT 115kg(255lbs)</b>		

**2**

**karma** SERIAL NO. M12-1234

**3**

Model:	
Order No.:	
Delivery Date:	
Sewing No.: <input type="checkbox"/> 1 <input type="checkbox"/> 2 <input type="checkbox"/> 3 <input type="checkbox"/> 4 <input type="checkbox"/> 5 <input type="checkbox"/> 6	
Seat Width	Seat Depth
<input type="checkbox"/> 13	<input type="checkbox"/> 13
<input type="checkbox"/> 14	<input type="checkbox"/> 14
<input type="checkbox"/> 15	<input type="checkbox"/> 15
<input type="checkbox"/> 16	<input type="checkbox"/> 16
<input type="checkbox"/> 17 <input type="checkbox"/> 0	<input type="checkbox"/> 17 <input type="checkbox"/> 0
<input type="checkbox"/> 18 <input type="checkbox"/> 5	<input type="checkbox"/> 18 <input type="checkbox"/> 5
<input type="checkbox"/> 19	<input type="checkbox"/> 19
<input type="checkbox"/> 20	<input type="checkbox"/> 20
<input type="checkbox"/> 21	<input type="checkbox"/> 21
<input type="checkbox"/> 22	<input type="checkbox"/> _____
<input type="checkbox"/> _____	<input type="checkbox"/> _____
<b>karma</b>	Unit: inch
105-90039 Rer.02	

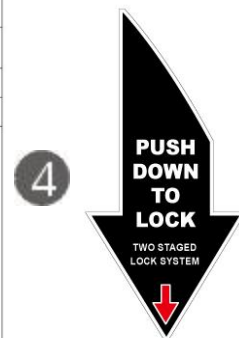

## 3. INTENDED USE & PARTS

### 3.1 Intended Use

- 3.1.1 The STAR/STAR 2 is a self-propelled or transit wheelchair. That is, it can either be propelled by an attendant (transit) or by the user (self-propelled). If it be equipped with 14" rear wheels then it just can be propelled by attendant only.
- 3.1.2 These wheelchairs are suitable for users up to STAR 100kg/STAR 2 115kg in weight. Hand brakes are provided for both rear wheels.
- 3.1.3 It has optional pneumatic tyres (tires) for traction and comfort. It also has an extremely durable aluminum alloy frame with tough accessories and does not suffer in dramatic extremes of temperature (neither user nor attendant need touch metal parts in normal use).
- 3.1.4 When prescribing wheelchairs for use by full or partial amputees (above or below knee, single or double) or other conditions that affects the users natural center of gravity, we suggest contacting your therapist or dealer as well as attaching anti-tippers.

### 3.2 STAR with with 24" Rear Wheel Parts Description

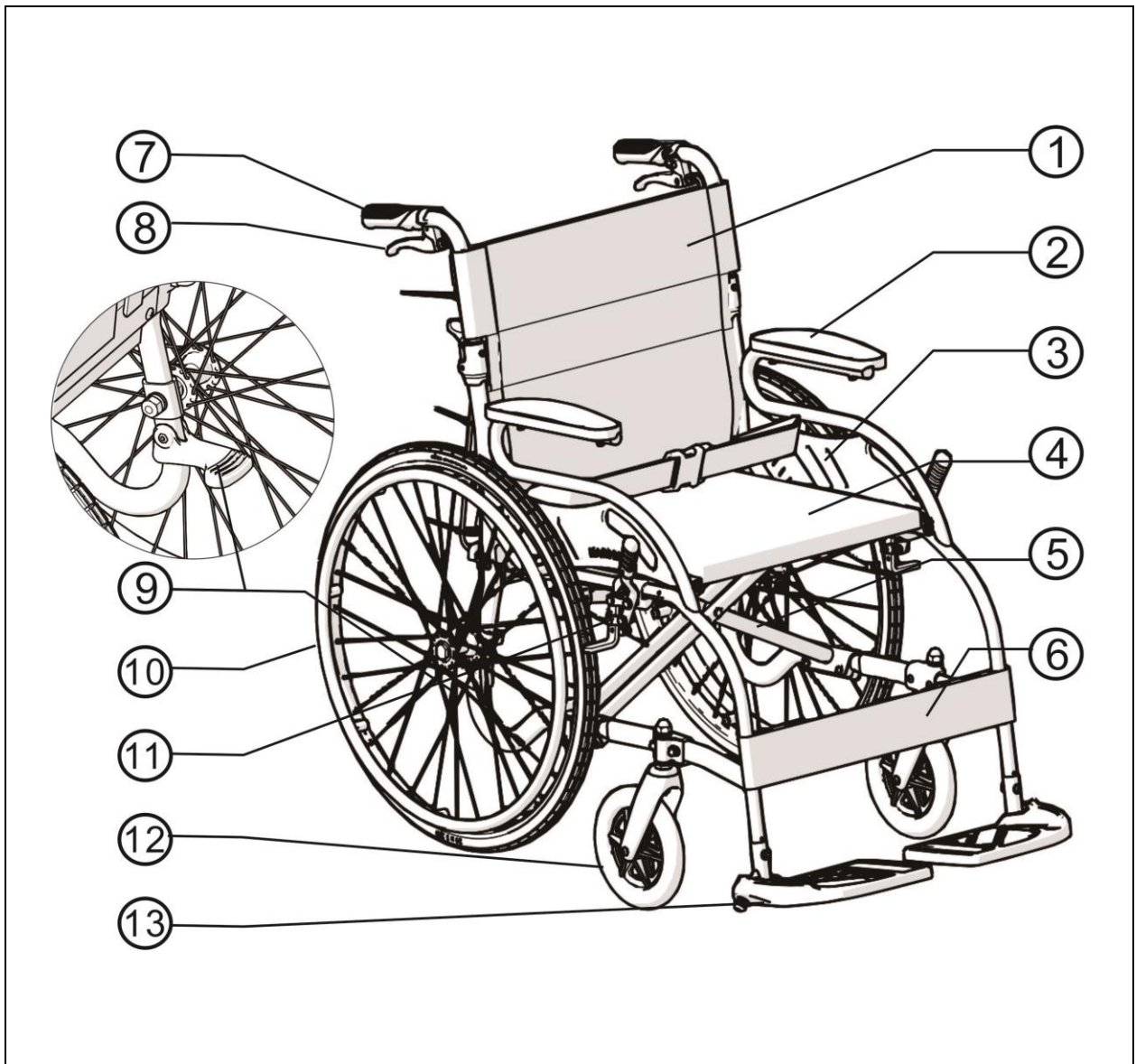

1. Backrest Upholstery

2. Armrest

3. Side Panel

4. Seat Upholstery

5. Cross Frame (Cross Bar)

6. Calf strap

7. Push Handle

8. Attendant Brake

9. Tipping lever

10. Rear Wheel

11. Hand Brake

12. Caster

13. Footplate

### 3.3 STAR 2 with 24" Rear Wheel Parts Description

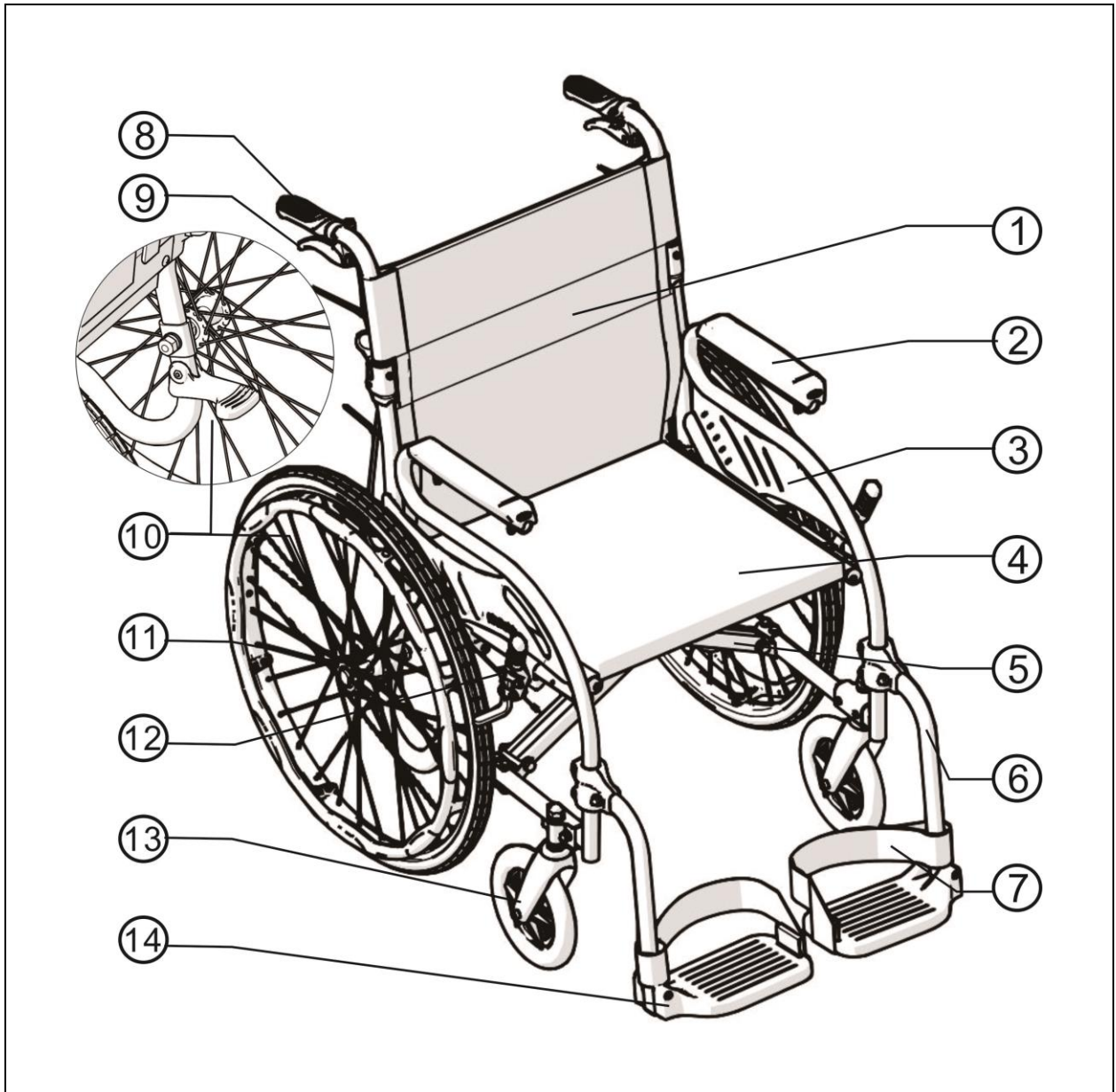

- 1. Backrest Upholstery
- 2. Armrest
- 3. Side Panel
- 4. Seat Upholstery
- 5. Cross Frame (Cross Bar)
- 6. Footrest
- 7. Calf Strap

- 8. Push Handle
- 9. Attendant Brake
- 10. Tipping lever
- 11. Rear Wheel
- 12. Hand Brake
- 13. Caster
- 14. Footplate

### 3.4 STAR 2 with 14" Rear Wheel Parts Description s

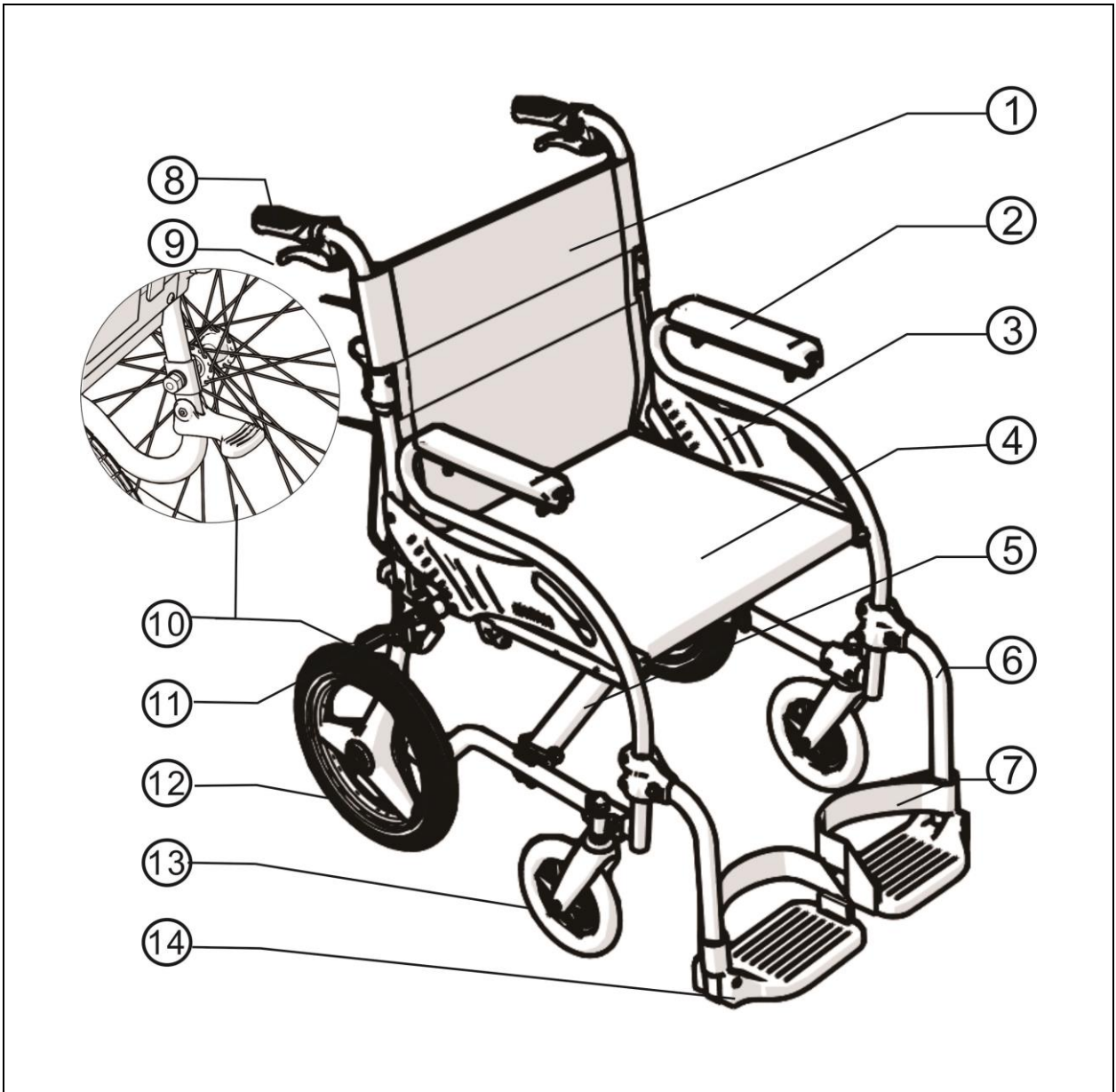

1. Backrest Upholstery

2. Armrest

3. Side Panel

4. Seat Upholstery

5. Cross Frame (Cross Bar)

6. Footrest

7. Calf Strap

8. Push Handle

9. Attendant Brake

10. Tipping lever

11. Rear Wheel

12. Hand Brake

13. Caster

14. Footplate



## 4. OPERATION

### 4.1 Preparing For Use

#### 4.1.1 Unfolding

4.1.1.1 Unfold the push handle. (See Figure 4.1)

4.1.1.2 Holding the armrests, pull outwards. (See Figure 4.2)

4.1.1.3 Pointing your fingers inward with the palm of your hand on the frame, push down until the seat is fully lowered. Make sure you hear the "CLICK" sound and the frame is firmly seated in its holder. (See Figure 4.3)

4.1.1.4 Lift the footrests upward, swing them towards the middle and push them down until they are fully locked. (See Figure 4.5 - Figure 4.5)

4.1.1.5 Swing the footplates down. (See Figure 4.6)

4.1.1.6 Ready for action!

Alternatively, you can stand at the side of the wheelchair and complete step 1 by pulling the nearest armrest towards yourself and pushing the other one away.

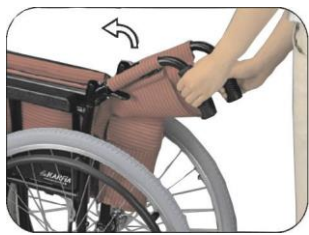

Figure 4.1



Figure 4.2



Figure 4.3

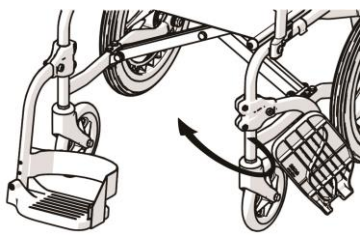

Figure 4.4

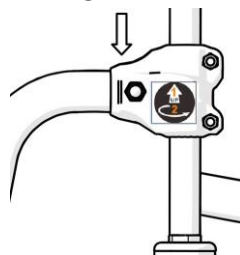

Figure 4.5

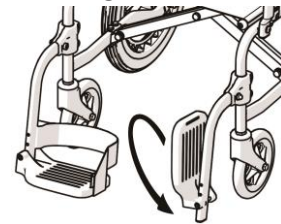
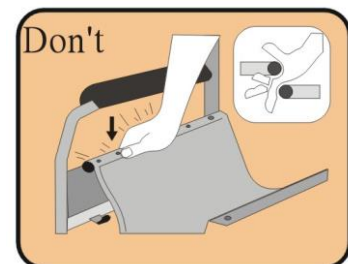

Figure 4.6

While completing step 2, never put your fingers around the sides or under the wheelchair as they can be trapped between the seat and the frame. (See the right figure.)



## 4.1.2 Folding

4.1.2.1 Flip up the footplates. (See Figure 4.7)

4.1.2.2 Lift the footrests upward, swing them outward to the side and push them down until they are fully locked. (See Figure 4.8 · Figure 4.9)

4.1.2.3 Pull up on the seat upholstery by holding it in the center of its front and back edge. (See Figure 4.10)

4.1.2.4 Press the two release levers on the backrest frame (push handle tubes) to fold the backrest down for compact storage and easy transport.(See Figure 4.11)

4.1.2.5 Folding is now completed.

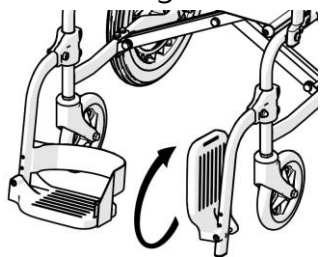

Figure 4.7



Figure 4.8

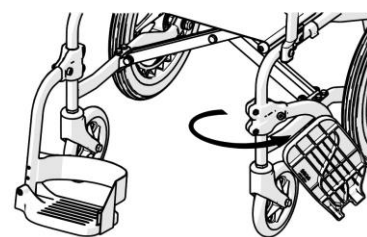

Figure 4.9



Figure 4.10



Figure 4.11



### CAUTION:

- Be careful not to get your fingers caught when folding the wheelchair.

## 4.1.3 Adjustments

4.1.3.1 Your wheelchair may be supplied with quick-release wheels. If so, please follow the instructions below

## 4.1.4 Rear Wheel Removal

4.1.4.1 Support the weight of the chair with one hand by holding the push handle.

4.1.4.2 Depress the hub cover and hold down the quick-release mechanism.

4.1.4.3 Remove the wheel. (See Figure 4.12)

## 4.1.4.4 Rear Wheel Attachment

4.1.4.4.1 Pick up the wheel: Hold the center of the rear wheel by grasping two

adjacent spokes with four fingers of one hand, use the thumb to depress and keep depressed the quick-release. Take the quick-release axle and depress the button in its center. This retracts the bearings at the opposite end of the axle. This will allow you to push the axle through the center of the hub of the wheel. Your wheels are now ready to be assembled to the frame of your wheelchair.

4.1.4.4.2 First ensure that the brake is in the OFF position. Take up the assembled wheel and axle and depress the button in the center of the axle, as above. This retracts the ball bearings that will allow you to push the axle into the wheel bracket that is located on the lower rear frame of the wheelchair. When you remove your thumb from the button on the axle, the ball bearings should be visible protruding from the axle at the back of the wheel bracket. This will secure the wheel safely in the frame. (See Figure 4.13)



#### CAUTION:

- You must make sure that the axle is fully located in the wheelchair bracket and that the ball bearings are fully open and have positively attached the wheel in the frame.
- The rear wheel can be mounted at different positions on the frame to alter the seat height and overall stability of the chair. Changing the wheel position should be carried out by your approved repairer or therapist.



Figure 4.12



Figure 4.13

#### 4.1.5 Important DO's and DON'Ts

4.1.5.1 Do: keep axles clean and lubricate with light oil or maintenance spray.

4.1.5.2 Do: maintain correct tyre pressure if pneumatic tyres are used.

4.1.5.3 Do not: Try to detach the wheels while the wheelchair is occupied even it is installed with anti-tippers.

#### 4.1.6 Adjust Footplate Height

4.1.6.1 To adjust footplate height use the Karma tool provided to loosen the bolt at the bottom of the footrest arm.

4.1.6.2 Adjust to required height and re-tighten. (See Figure 4.17)



Figure 4.17



Figure 4.18

#### **i** SUGGESTION:

- Make sure that the footplate height is adjusted properly according to the users calf length to reduce pressure on the body.
- The footplate height must be at least 5cm from the ground. (See Figure 4.18.)

#### 4.1.7 How to use the tipping lever

4.1.7.1 Unfold the tipping lever with foot slightly. (See Figure 4.19).

4.1.7.2 Step the tipping lever downward with foot and hold the both push handles and push them downward by two hands simultaneously to lift the caster to overcome the obstacle. (See Figure 4.20)

4.1.7.3 The tipping lever can be folded with foot if you do not use it. (See Figure 4.21)



Figure 4.19



Figure 4.20



Figure 4.21

## 4.1.8 Footrest Installation and Adjustment

Install footrest:

4.1.8.1 Unpack the footrest box and take the footrest out of the box. Unscrew the screws of the footrest by using 5mm Allen key which bundled in the tool box. (Figure 4-22).

4.1.8.2 Attach the sleeve to the front tube (slot side faces inwardly) and align it with the hole. (Figure 4-23)

4.1.8.3 Fix the footrest with the sleeve and tube. (Figure 4-24)

4.1.8.4 Lock the footrest with screws and Hex. nut. (Figure 4-25)

Adjust footrest:

4.1.8.5 Loose screws by using 5mm Allen key which bundled in the tool box and adjust the length to an appropriate position to fit user' s leg-length. (Figure 4-26)



Figure 4.22

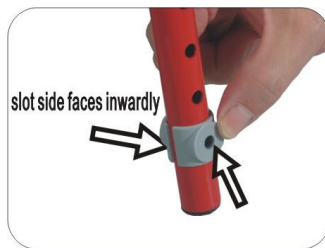

Figure 4.23



Figure 4.24



Figure 4.25



Figure 4.26

## 4.2 Transferring In and Out

### 4.2.1 Transferring In

4.2.1.1 Engage both hand brakes.

4.2.1.2 Turn the footplates up and swing them to the side.

4.2.1.3 The user lowers his or her body into the seat using the armrests for support.

4.2.1.4 Turn the footplates back down, so that the user can place his feet on them.

4.2.1.5 Release both hand brakes.



#### CAUTION:

- Always ensure that the front casters are in line with the rear wheels and pointing forwards and that the back of the wheelchair is secure either against a wall or firmly held by an attendant.

### 4.2.2 Transferring Out

- 4.2.2.1 Make sure that the chair is near your final destination.
- 4.2.2.2 Back the chair sufficiently to ensure that the casters are pointing forward, i.e. in line with the rear wheels and usually with the caster forks pointing forward. Ensure that, where possible, the rear of the chair is against a wall or, if not, it must be firmly held by an attendant.
- 4.2.2.3 Engage both hand brakes.
- 4.2.2.4 Turn the footplates up and swing them to the side..
- 4.2.2.5 Slide forwards on the seat.
- 4.2.2.6 Place one foot firmly on the ground with the knee at a right angle and the other foot slightly apart and further back.
- 4.2.2.7 Place your hands on the front of the armrests and moving your weight forward, bring your head and shoulders up over your knees as you push yourself up.



#### CAUTION:

- Never stand on the footplates when getting into (or out of) the wheelchair. (See Figure 4.27)
- When getting in and out of the wheelchair please use the hand brakes. The hand brake is the lever at the side of the wheelchair.
- Please ensure that neither the tread on your tyres nor the brake block becomes too worn.
- If pneumatic tyres are fitted, please maintain at the recommended tyre pressure for the same reason.
- Please ensure that occupant's fingers do not get caught in the brake.

When transferring in and out of the wheelchair, make sure that the brakes are applied to prevent the wheelchair from sliding away. Also see that the footplates are flipped up for ease of entering or exiting. (See Figure 4.28)

## 4.3 General Use

### 4.3.1 Attendant Pushing and Self-propelled

4.3.1.1 Do ensure that the brakes are always locked when the wheelchair is not being pushed. (See Figure 4.29)

4.3.1.2 Always make sure that both feet are safely on the footplates and that clothing is safely tucked out of the way and so cannot get caught in the wheels. (See Figure 4.30)

4.3.1.3 Always use both hands on the push handles to control the wheelchair. (See Figure 4.31)

4.3.1.4 Always avoid steep or uneven surfaces because the wheelchair may tip over. (See Figure 4.32)

4.3.1.5 Always avoid soft surfaces because the casters may get bogged down. (See Figure 4.33)

4.3.1.6 Always be careful not to go too fast or turn too quickly and try to achieve a smooth steady ride.

4.3.1.7 Before crossing railroad tracks, please stop completely and look both ways.

4.3.1.8 Cross the tracks perpendicular to avoid your wheels getting stuck.

4.3.1.9 Do not move at full speed over the railroad tracks.

4.3.1.10 Be careful when going through a doorway that your hands and arms do not get injured.

PLEASE keep in contact with the person in the wheelchair. If you stop to look in shop windows or talk to people, remember to turn the wheelchair so that the person in the wheelchair does not have to turn.

### WARNING:

- NEVER lock the brakes too quickly as this may tip the user out of the wheelchair.



Figure 4.27



Figure 4.28



Figure 4.29



Figure 4.30



Figure 4.31



Figure 4.32



Figure 4.33



Figure 4.34

### 4.3.2 Tilting by the Attendant

4.3.2.1 Make sure both the user's feet are on the footplates and will not slip off.

Make sure the handgrips are secure and cannot slip off.

4.3.2.2 Release both brakes.

4.3.2.3 Grasp both push handles firmly.

4.3.2.4 Put your stronger foot on the relevant tipping lever at the back of the wheelchair.

4.3.2.5 Tell the person in the wheelchair that you are about to tilt the wheelchair backwards.

4.3.2.6 Pull back with both hands and push down and forwards with the foot. This will bring the wheelchair onto the back wheels. (See Figure 4.34)



#### CAUTION:

- When a wheelchair is tilted to about 25 degrees it will balance on its rear wheels and be easy to hold. If it is tilted further back it will be difficult to hold and the person in the wheelchair will feel unsafe.
- Lower the wheelchair with your back straight, keep your foot on the anti-tipper and lower the wheelchair slowly forwards softly to the ground.

### 4.3.3 Tilting by the User

4.3.3.1 Make sure your feet are on the footplates and will not slip off.

4.3.3.2 Release both brakes.

4.3.3.3 Grasp both push rims and give a firm, sudden forward push immediately



before the obstacle, continue the momentum (be ready to keep pushing) until the obstacle is mounted.



#### CAUTION:

- This method should only be attempted by people experienced in wheelchair use. Strong arms are also necessary. It is always better to have the help of an attendant.
- Leaning backwards causes the caster to rise higher BUT it is much safer to lean forwards and stay balanced.

#### 4.3.4 Going Down Kerbs

Please note: It is always better to avoid kerbs where possible by using ramped kerbs or slopes and this operation is best attempted with the aid of an attendant.

##### 4.3.4.1 Going Down Kerbs Forwards With an Attendant



#### CAUTION:

- This is the more difficult method and can jar the user but allows a better view of traffic.
- Be careful that the anti-tipper does not get caught on the kerb causing the user to fall.
- **NEVER ALLOW THE WHEELCHAIR TO TIP FORWARDS WHEN GOING DOWN A KERB.**

4.3.4.1.1 Position the wheelchair so that the front casters are near the edge of the kerb and make sure that the road is clear.

4.3.4.1.2 Move the wheelchair slowly and carefully forwards while tilting it back slightly. Be ready to take the weight when the rear wheels cross the kerb edge. Ensure that both rear wheels touch the ground at the same time to avoid tipping the wheelchair.

4.3.4.1.3 Gently lower the front casters. **AVOID JARRING THE USER.**

##### 4.3.4.2 Going Down Kerbs Backwards With an Attendant



#### CAUTION:

- This is the easier and smoother method BUT it requires the attendant to step backwards into the road

4.3.4.2.1 Back the wheelchair to the kerb edge and be careful that the back wheels are equally near the edge.

4.3.4.2.2 Grasping the push handles, gently lower the rear wheels onto the road. Be prepared to control the weight as it descends and ensure that the back wheels touch ground at the same time.

4.3.4.2.3 Tilt the wheelchair back slightly and pull the tilted wheelchair far enough into the road so that the casters and footrests can be lowered clear of the kerb.

#### 4.3.5 Going Up Kerbs

Please note: This operation is best attempted with the aid of an attendant and the best method is to go up kerbs forwards as this maintains the direction of travel and is physically less demanding for the attendant.

##### 4.3.5.1 Going Up Kerbs Forwards With an Attendant

4.3.5.1.1 As the footrests nearly touch the kerb tilt the wheelchair. The wheelchair should be tilted just high enough to allow the front casters to roll smoothly onto the pavement.

4.3.5.1.2 Push the wheelchair forward until the rear wheels are touching the kerb. Then, continuing the movement, lift at the push handles while moving the wheelchair forwards.

##### 4.3.5.2 Going Up Kerbs Backwards With an Attendant

Please note: for safety's sake we do not recommend using this method.

#### 4.3.6 Going Up or Down Steps/Stairs

4.3.6.1 Please note: avoid flights of steps particularly if no extra help is available. Use ramps or lifts wherever possible.

4.3.6.2 Two attendants are necessary, each capable of carrying at least half of the combined weight of the person and the wheelchair.

4.3.6.3 Each helper should bend at the knees and grip the main frame: with the front attendants hands just under the front of the seat, with the back attendant's hands holding the frame just under the push handles.



#### CAUTION:

- Never hold on to movable or detachable parts

ALL LIFTING SHOULD BE DONE WITH A STRAIGHT BACK.

Straighten legs to lift the wheelchair. Carefully carry it up or down steps; be aware of how you place your feet -- do not cross them and trip yourself up.

## 4.4 Storing

Make sure the wheelchair is folded when stored.



### SUGGESTION:

- Please store the wheelchair in a location where it is out of direct sunlight, rain and dew. For more details, consult your KARMA dealer.



### WARNING:

- Don't put anything on the wheelchair while it is in storage. Storing goods on a folded or unfolded wheelchair will cause damage and is not covered under warranty. (See Right Figure.)



## 4.5 Transportation

4.5.1 KM-1514 fulfils the performance requirements for a “Crash Test” of ISO 7176-19 and is suitable to use as a seat in vehicles that have been adapted for this purpose. The wheelchair must be securely restrained as described in this manual. KM-1514 was tested with a four point webbing system. For further information on the use of wheelchair restraints please refer to the manufacturer's user guide.

4.5.2 KARMA always recommend that the user transfers to the vehicle seat, because using a wheelchair as a seat in a vehicle does not provide the equivalent level of safety of a vehicle seating system.



### SUGGESTION:

- Please transfer to a vehicle seat in the vehicle in all permitted cases.

 **WARNING:**

- As of this date, the KM-1504 cannot be used as seats in any vehicles. That is, KARMA recommends that users are NOT transported in any vehicle while seated in the wheelchair. In the case of accident or a sudden stop, the user or passengers may be at risk of getting injury. The suggested solution is to transfer the user from the wheelchair into a vehicle seat and to securely stow the wheelchair in a separate compartment.

#### 4.5.3 Before use

4.5.3.1 Please detach all easily removable accessories from the wheelchair and store them in a safe place where they cannot move around and become a safety hazard.

4.5.3.2 A four point tie-down system should tightly fasten the lower wheelchair frame to the transport vehicle. The Tie Down Label (see the hook mark at the right) indicates the position of the fixing points for the tie down restraints on the wheelchair.



4.5.3.3 An occupant restraint system using both a pelvic belt and harness must also be fastened to the transport vehicle to insure user safety. Again, please refer to the restraint system's instructions.

4.5.3.4 The attendant / transporter must double-check all fastening points for proper connection and tightness to assure the wheelchair user's safety. The attendant / transporter must fully understand how to use the fastening system and its weight limitations.

4.5.3.5 See <http://www.unwin-safety.com/> for more information.

 **CAUTION:**

- When transporting or lifting, never hold on to attachments or accessories (front/rear wheels, handrims, casters, footrests, armrests, anti-tippers etc.).

#### 4.5.4 Method of Restraint

4.5.4.1 The Star2 (KM-1514) was tested with four point webbing systems. Please refer to the restraint manufacturer's user guide for further details of its operation.

#### 4.5.6 Fitting the Front Restraint

4.5.6.1 Connect the straps around the wheelchair frame and caster bracket as pictured below. The anchor point is marked with a yellow sticker.

4.5.6.2 Release the brakes and reverse the wheelchair to tension the front straps.

Apply wheelchair brakes (the brakes should be left on during transport).

#### 4.5.7 Fitting the Rear Restraint

4.5.7.1 Attach rear straps into rail approximately 300 mm behind the wheelchair backrest.

4.5.7.2 Attached the hooks to the rear frame of the wheelchair as pictured below.

Tension the restraint until the wheelchair is secure.



Fitting the front restraint



Fitting the rear restraint

#### 4.5.8 Fitting seat beat

4.5.8.1 Fasten the three point safety belt around the user.

4.5.8.2 The occupied wheelchair should be located in a forward-facing configuration, with the parking brake applied.

4.5.8.3 Pelvic restraints should make full contact across the front of the body near the junction of the thigh and pelvis as pictured below (correct seat belt position).

4.5.8.4 Restraints should not be held away from body by wheelchair components such as armrest or wheels as pictured below (Incorrect seat belt position).

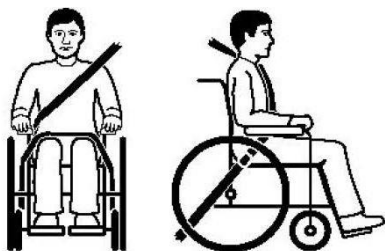

Correct seat belt position



Incorrect seat belt position

## 4.6 Pelvic Belt (Option)

### 4.6.1 How to assemble and disassemble the pelvic belt

4.6.1.1 Loosen the fourth and fifth screws of both side of seat upholstery and insert the pelvic belt in between the fourth and fifth screw holes. (Figure 4.35)

4.6.1.2 Keep the pelvic belt in 45 deg for comfortable usage. (Figure 4.36)

4.6.1.3 Put the seat upholstery back and tighten screws.

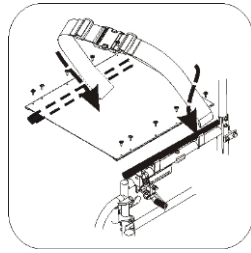

Figure 4.35

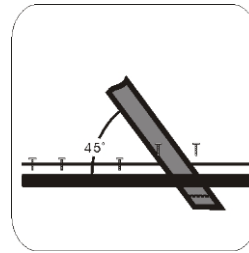

Figure 4.36

### 4.6.2 Adjusting length of seat belt

4.6.2.1 Identify the require length of the belt. (Figure 4.37)

4.6.2.2 Push the two part of belt through buckle to make the belt longer or shorter. (Figure 4.38)

4.6.2.3 Pull the two part of belt tight. (Figure 4.39)

4.6.2.4 Push buckle up to the plastic clip so that the belt cannot slip out of position. Please check that there is no gap between the clip and buckle. (Figure 4.40)



### WARNING:

- We recommend that the belt is fitted quite tightly around the pelvis. Please tighten until you can just get your fingers between user and seat belt. Please check that the belt is fastened correctly as recommended. If this is not possible please consult your supplier..



Figure 4.37



Figure 4.38



Figure 4.39



Figure 4.40

#### 4.6.3 How to operate it:

4.6.3.1 When you sit on the wheelchair, fasten the pelvic belt.

4.6.3.2 Adjust the belt and make it fit your body for comfort and security.

4.6.3.3 When you don't use it, please fasten the belt to avoid the belt dropping into rear wheels during motion.

#### 4.6.4 Maintenance

The pelvic belt is made from 100% polyester fiber and the clasp is made from plastic. It does not require any maintenance but should be inspected every month to ensure that the edges are not frayed and weekly to make sure that it correctly fits the user. If there are any signs of deterioration, please replace it immediately.

## 5. INSPECTION AND MAINTENANCE

### 5.1 Daily Check

Check the following items before traveling. If you find anything abnormal, visit your KARMA wheelchair dealer for further inspection before using it.

5.1.1 Examine brakes, checking for wear, damage and misalignment. Replacing or adjusting the brakes should be carried out by your approved repairer.

5.1.2 Check that the handgrips are not damaged and are securely bonded to the push handles.

5.1.3 Check anti-tippers are not damaged and are securely attached.

5.1.4 Check that the anti-tippers' wheels and frame are not damaged and are securely mounted.

5.1.5 Before using the wheelchair, make sure all nuts and bolts are tight. Check all parts for damage or wear and have a qualified technician replace it if necessary. Check all parts for proper adjustment. Inspect brakes for proper operation.

5.1.6 The wheels and tyres should be checked periodically for cracks and wear, and should be replaced by a qualified technician.

5.1.7 A qualified technician can be found at an authorized distributor/dealer.



#### **CAUTION:**

- Visit a KARMA wheelchair dealer for inspection and maintenance if you find anything abnormal.

## 5.2 Regular Maintenance Record

In order to ensure that your wheelchair is in good condition, please contact Karma authorized dealers regularly and make further wheelchair inspection and maintenance records. We recommend that you inspect and maintain your wheelchair every six months.

A maintenance/service fee may apply.



### WARNING:

- Even if you don't use the vehicle for a long time, the wheelchair should still be maintained regularly. You should clean your wheelchair regularly..

● Item	Weekly	Monthly
<b>GENERAL</b>		
● ● Wheelchair rolls straight (no excessive drag or pull to one side)		V
<b>FRAME AND CROSS BARS</b>		
● ● Inspect frame structure for small cracks/fissures		V
● ● Inspect for bent frame or cross bars		V
<b>BRAKES</b>		
● ● Do not interfere with tyres when rolling		V
● ● Pivot points free of wear and looseness		V
● ● Easy to engage	V	
● ● Prevent wheelchair from moving when engaged	V	
<b>SEAT &amp; BACKREST</b>		
● ● Inspect for rips or sagging	V	
● ● Inspect for loose or broken hardware		V
<b>CASTERS</b>		
● ● Inspect the casters for smooth rotation of the caster wheel and caster assembly		V
● ● Inspect the caster for wear in the bearings/mountings and for tyre wear or damage		V
<b>REAR WHEELS</b>		
● ● Quick-release axles lock properly; lubricate if necessary	V	



● Item	Weekly	Monthly
● ● No excessive side movement or binding when lifted and spun		✓
● ● Inspect for cracked, bent or broken spokes	✓	
<b>ARMRESTS</b>		
● ● Inspect the detachable armrest button for effective locking		✓
● ● Make sure the armrest detaches and flips back properly		✓
<b>FOOTRESTS</b>		
● ● Inspect the footplate height adjustment screws are securely tightened		✓
● ● Inspect the swing-away footrest release lever for effective locking		✓
<b>TYRES</b>		
● ● Inspect for flat spots, cracks and wear	✓	
● ● Check tyre tread depth is more than 1mm		✓
● ● If pneumatic tyres, check for proper inflation; tyre pressures are located on the side of the tyre	✓	

 **CAUTION:**

- If you find anything abnormal, stop using the wheelchair immediately and visit a KARMA wheelchair dealer for inspection and maintenance.
- As with any wheelchair, the wheels and tyres should be checked periodically for cracks and wear, and should be replaced. Failure to keep tyres at the correct pressure will reduce the braking efficiency.
- Never disassemble or modify the wheelchair frame structure. Otherwise, injury or damage may occur. This will void the warranty.

## 6. OPTIONS AND ACCESSORIES

	<ul style="list-style-type: none"> <li>● Backrest Bag           <ul style="list-style-type: none"> <li>- Standard size.</li> <li>- Attaches to all KARMA manual wheelchairs</li> </ul> </li> </ul>
-----------------------------------------------------------------------------------	----------------------------------------------------------------------------------------------------------------------------------------------------------------------------------------------------



### CAUTION:

- Attaching accessories may alter the overall stability and center-of-gravity of the chair.
- Thus, this should be performed by your approved repairer and therapist.

## 7. TROUBLESHOOTING

### 7.1 Trouble or Problems with Your Wheelchair

You can inspect the following before taking your wheelchair to a KARMA wheelchair dealer.

Problem	Checking Points and Corrective Action
<ul style="list-style-type: none"> <li>● 1. Wheelchair Veers Right/Left</li> </ul>	<ul style="list-style-type: none"> <li>● Check the tyres for correct and equal pressure</li> <li>● Check the caster bracket angle</li> <li>● Check that the rear wheels are equally spaced from the seat frame</li> </ul>
<ul style="list-style-type: none"> <li>● 2. Sluggish Turn or Performance</li> </ul>	<ul style="list-style-type: none"> <li>● Check the tyres for correct and equal pressure</li> <li>● Check for loose nuts and bolts</li> </ul>
<ul style="list-style-type: none"> <li>● 3. Caster Flutter/Wobble</li> </ul>	<ul style="list-style-type: none"> <li>● Check the tyres for correct and equal pressure</li> <li>● Check for loose nuts and bolts</li> <li>● Check the caster bracket angle</li> </ul>
<ul style="list-style-type: none"> <li>● 4. Squeaks and Rattles</li> </ul>	<ul style="list-style-type: none"> <li>● Check for loose nuts and bolts</li> </ul>
<ul style="list-style-type: none"> <li>● 5. Looseness in Wheelchair</li> </ul>	<ul style="list-style-type: none"> <li>● Check for loose nuts and bolts</li> </ul>

If you cannot solve the problem by yourself, contact your KARMA wheelchair dealer for help.

## 8. SPECIFICATIONS

( ±5 mm, ±0.5 kg )

Model	STAR (KM-1504)	STAR2 (KM-1514)			
Seat Width* Seat Depth (inch)	18"*17"	16"*17"		18"*17"	
Seat Width (mm)	450	400	400	450	450
Seat Depth (mm)	430	430	430	430	430
Caster Size (inch)	7	7	7	7	7
Rear Wheel Size (inch/QR)	F24	F14	F24	F14	F24
Seat Height (mm)	500	500	500	500	500
Backrest Height (mm)	420	420	420	420	420
Armrest Height (mm)	220	220	220	220	220
Calf Length (mm)	380~430	430~470	430~470	430~470	430~470
Backrest Angle (°)	14	12	12	12	12
Seat Angle (°)	7	5	5	5	5
Legrest Angle (°)	80	80	80	80	80
Max. User Weight (kg)	115	115	115	115	115
Weight W/O Accessories (kg)	12.2	12.2	12.8	12.6	13.2
Total Weight (kg)	12.5	12.5	13.1	12.9	13.5
Overall L x W x H (mm)	1020*670*890	940* 600* 920	1000* 620* 920	940* 650* 920	1000* 670* 920
Overall Collapsed L x W x H (mm)	1000*280*780	650* 270* 770	780* 290* 770	650* 270* 770	780* 290* 770

<b>Static Stability Test (According to 7176-1:1999)</b>		
<b>STAR Dummy used is 100 kg / STAR2 Dummy used is 115 kg</b>		
	STAR 18" F24" PU	STAR 2 18" F24" PU
Tipping Angle	STAR (KM-1504)	STAR2 (KM-1514)
Front Wheels Unlocked	19°	12°
Backward Rear Wheels Locked	12.4°	15°
Sideways	18°	17°

## 9. CLEANING & RECYCLING

### 9.1 Cleaning

In order to lengthen the life of your wheelchair, it is suggested that you clean the wheelchair periodically (if not daily), especially after it is used in the rain or snow. We suggest that you don't use your wheelchair in the rain or snow. If you are traveling and get caught in the rain, we suggest you try to find shelter while waiting it out. If you can't find shelter, proceed to your destination.

#### 9.1.1 Frame

Wipe the frame with a damp cloth.

#### 9.1.2 Upholstery

9.1.2.1 When cleaning the upholstery, use warm water and a mild soap.

9.1.2.2 Upholstery cleaner/foam can also be used, but avoid other cleaning solvents.

### 9.2 Post-Consumer Recycling

A post-consumer recycling plan should follow the Environmental Protection Administration's regulations. The items listed below are for reference only as local laws and regulations may vary.

Material	Part Name	Method
Aluminum-alloy	Frame	Recyclable
Plastic	Modular Components	Recyclable
Paper	Owner's Manual	Recyclable

9.2.1 There are many organizations in many countries you can find on the Internet that will accept used goods for charity. Please search the Internet to help less fortunate individuals and protect our planet for future generations. If you do not have access to the world wide web please use your local phone directory, ask for operator assistance or go to your local government center for more information. Earth Day is every day.

9.2.2 Check with your local recycling center on where and how to recycle your wheelchair as this information varies from region to region.

## 10. WARRANTY

### 10.1 Serial Number

To ensure after-sale service and warranty, please record and fill in the serial number which can be found on the frame.

This warranty is VOID if the original chair serial number is removed or altered.

Model	STAR / STAR 2 Series
Serial Number	

### 10.2 Warranty Policy

#### 10.2.1 Contents and Duration of Warranty

10.2.1.1 If the parts of the product need to be repaired or replaced due to manufacturing defects, they can be repaired or replaced free of charge within the warranty period (a repair of this kind will hereafter be called warranty maintenance).

10.2.1.2 Frame and cross-braces are warranted for a period of 5 years and gas strut for a period of 1 year after delivery to the customer, then the affected parts will be repaired or replaced free of charge.

10.2.1.3 Consumable parts such as brakes, bearings, footplates, pads, side guards, upholsteries, wheels and similar parts are excluded from the warranty.

10.2.1.4 Warranty maintenance can be performed by authorized KARMA wheelchair dealers only.

10.2.1.5 KARMA is not responsible for the transportation costs for repair and replacement.

10.2.1.6 Warranty maintenance is the repair or replacement according to the condition of the parts, and replaced parts will be the property of KARMA.

10.2.1.7 KARMA reserves the right to modify product specifications without further notice; KARMA is not responsible for any changes to product specifications.

## 10.2.2 The Claims from This Warranty Shall Not Arise for The Following Reasons

10.2.2.1 The product or part has been damaged by accident, improper use, incorrect assembly or poor maintenance. The evaluation of it is the privilege of KARMA.

10.2.2.2 Damage resulting from normal wear and tear.

10.2.2.3 Any overloading of the product, please check the label for maximum user weight.

10.2.2.4 The product or part has not been maintained or serviced in accordance with the manufacturer' s recommendations as shown in the User Manuals and/or the Service Manuals.

10.2.2.5 Use or install parts or accessories which are not manufactured or not approved by KARMA.

10.2.2.6 Damage resulting from use in unsuitable environments.

10.2.2.7 Damage resulting from any addition, modification, or alteration of the product or parts without the approval by KARMA.

10.2.2.8 Damage resulting from external factors, such as chemicals, oil, debris, etc.

10.2.2.9 Damage caused by natural disasters.

## 10.2.3 KARMA is Not Responsible for The Following Costs

10.2.3.1 Replacement or refill of consumable parts, oil or lubricant.

10.2.3.2 Product inspection, adjustment, lubrication, cleaning, etc.

10.2.3.3 The costs of regular inspection and maintenance of product.

10.2.3.4 The product is not repaired by the authorized dealer designated by Karma.

## 10.2.4 Responsibilities

### 10.2.4.1 The Responsibilities of the User

10.2.4.1.1 Fully adhere to operation guidelines set forth in this manual.

10.2.4.1.2 Perform self-inspection and basic maintenance.

10.2.4.1.3 Keep a record of self-inspections and basic maintenance.

10.2.4.1.4 Not permit any alteration, addition, or modification or use of parts not manufactured by KARMA.

10.2.4.1.5 Thoroughly read and understand this manual.

## 10.2.4.2 The Responsibilities of the Dealer

10.2.4.2.1 Follow this manual and educate user about product operation and basic maintenance.

10.2.4.2.2 Verify and check whether the warranty conditions are met.

10.2.4.2.3 Provide relevant warranty information and recommendations for improvements.

## 10.2.5 Transfer of Warranty Rights

If you purchase a second-hand KARMA wheelchair while it is still within the warranty period, bring this user manual and the wheelchair to the authorized dealer and perform necessary product inspection, maintenance and warranty inheritance procedure.

Full Name:	
Gender:	
Date of Birth:	
Address:	
Model:	
Serial Number:	
Date of Purchase:	

### Dealer's Data

Name of the Store:	
Phone Number and Address:	

If you have any suggestions on how to improve our products, please don't hesitate contacting your local dealer to let us know what you think of your wheelchair. Thank you and enjoy.

# karma

A Better Wheelchair, A Better Fit



KARMA MOBILITY S.L European Support Center.  
[www.karmamobility.es](http://www.karmamobility.es)  
+34 984 390 907  
[karma@karmamobility.es](mailto:karma@karmamobility.es)

KARMA MEDICAL PRODUCTS CO., LTD.  
[www.KarmaMedical.com](http://www.KarmaMedical.com)  
+886 5 206 6688  
[globalsales@karma.com.tw](mailto:globalsales@karma.com.tw)

11040000135 Release Date: Nov. 2020 V.08